



COMPASS DECOR



COMPASS DECOR

SHANDONG COMPASS DECOR MATERIAL CO.,LTD

Add: Rm1103, A10Building,Lushang Center,Guangzhou Road,
Lanshan District,Linyi City,Shandong Province,China

Tel: +86-539-7977830 Fax: +86-539-7977830
Whatsapp: +8618953955575 Wechat: +8618953955575
Email: angela@wpcspc.com Http: www.wpcspc.com



PRODUCT CATALOGUE

Flooring | Wall Panel | Accessories

2023-2025

COMPANY IMPLEMENTAT

Shandong Compass Decor Material Co.,Ltd is a company that focuses on the research, development and production of all kinds of fashionable, latest and best-selling decoration materials. Our main products: WPC panel,PS wall panel,Acousitic panel,UV board,outdoor cladding,outdoor decking,lvt& spc flooring,related accessories and so on.We have many years of export experience and are well-known in the industry, we are local in Linyi city, Shandong province, China.

Since its establishment, the company has always adhered to the business principle of customer first, reputation first, quality-oriented and service first, constantly developing new materials, innovating design and improving the quality management system, which can provide customers with all-round solutions and provide OEM,ODM services.



Our 30 person sales team is well-trained, experienced and responsive. We warmly welcome customers at home and abroad to visit and negotiate for win-win cooperation.

"Your trusting is our biggest power to go ahead", we're always here wait for serving for you.

CONTENTS

Wall Panel

- ◆ Wpc Wall Panel ----- 01-06
- ◆ Acoustic Panel ----- 07-08
- ◆ UV Board ----- 09-12
- ◆ PS Wall Panel ----- 13-14
- ◆ PVC Foam Board ----- 15-16
- ◆ Outdoor Cladding ----- 17-18

Flooring

- ◆ LVT Flooring ----- 19-22
- ◆ SPC Flooring ----- 23-26
- ◆ Outdoor Decking ----- 27-28

Accessories

- ◆ Skirting Board ----- 29
- ◆ Mouldings ----- 29-32
- ◆ Carpet Tack Strip ----- 33
- ◆ Installation Accessories ----- 33
- ◆ Factory&Certificate ----- 34

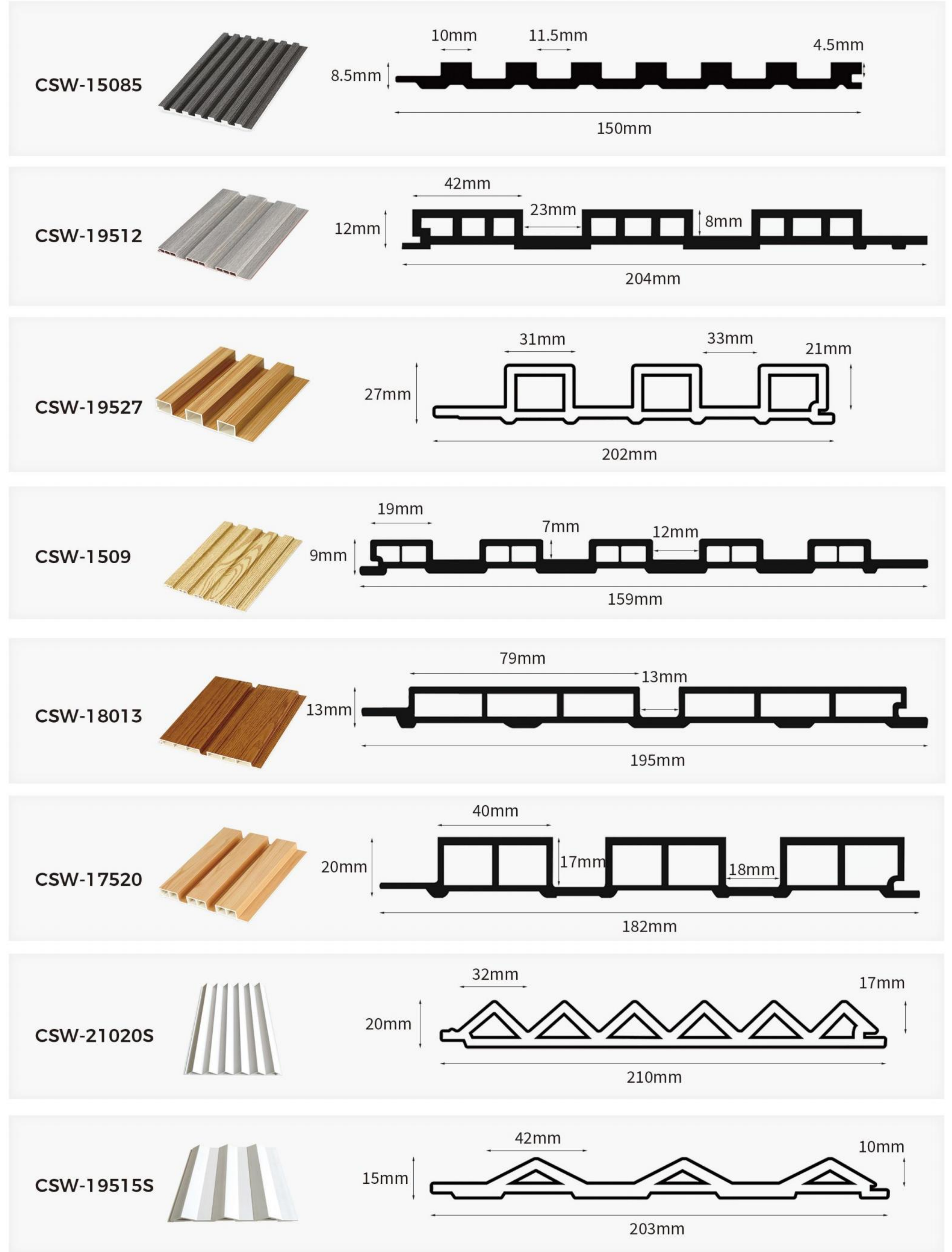
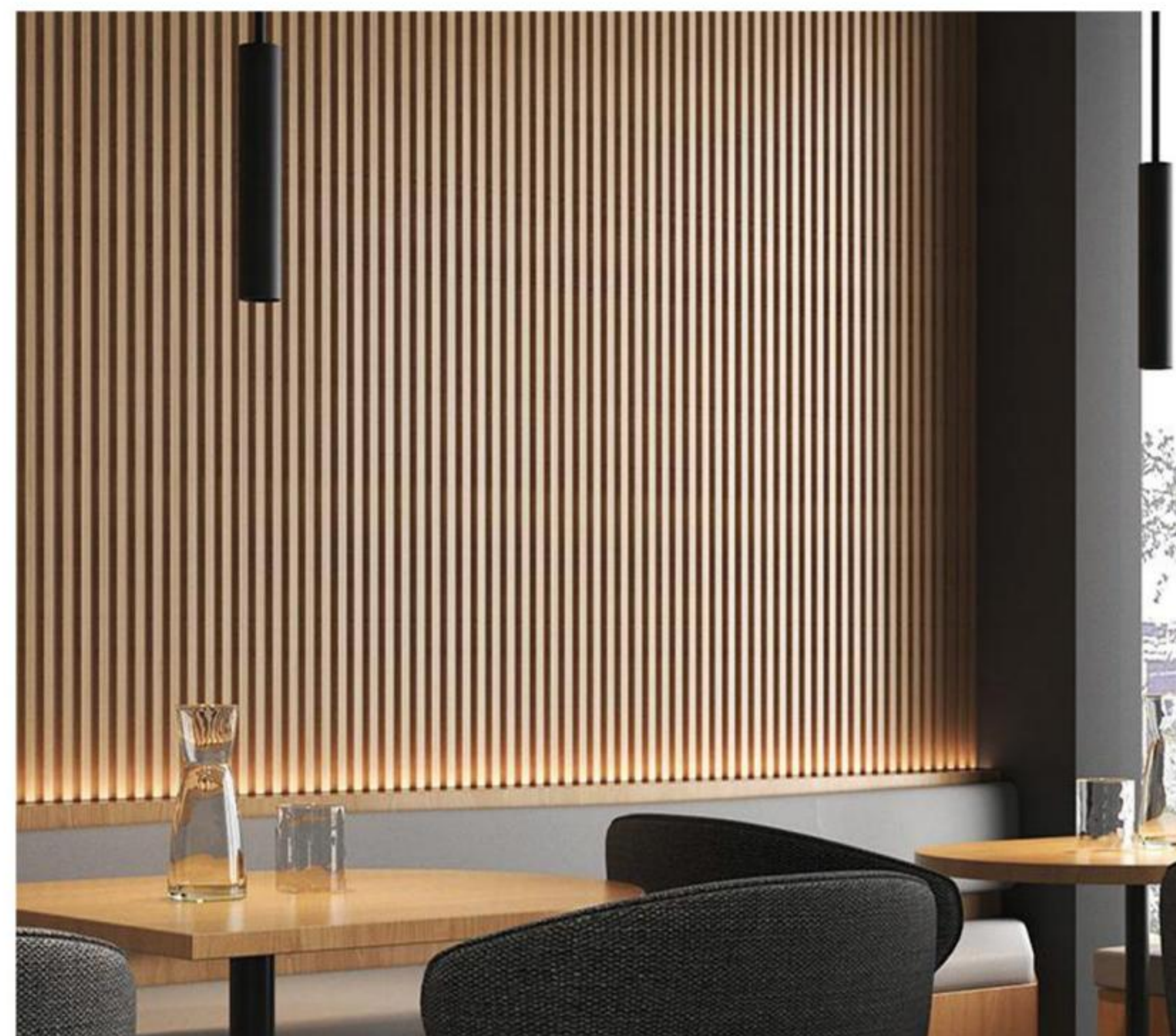

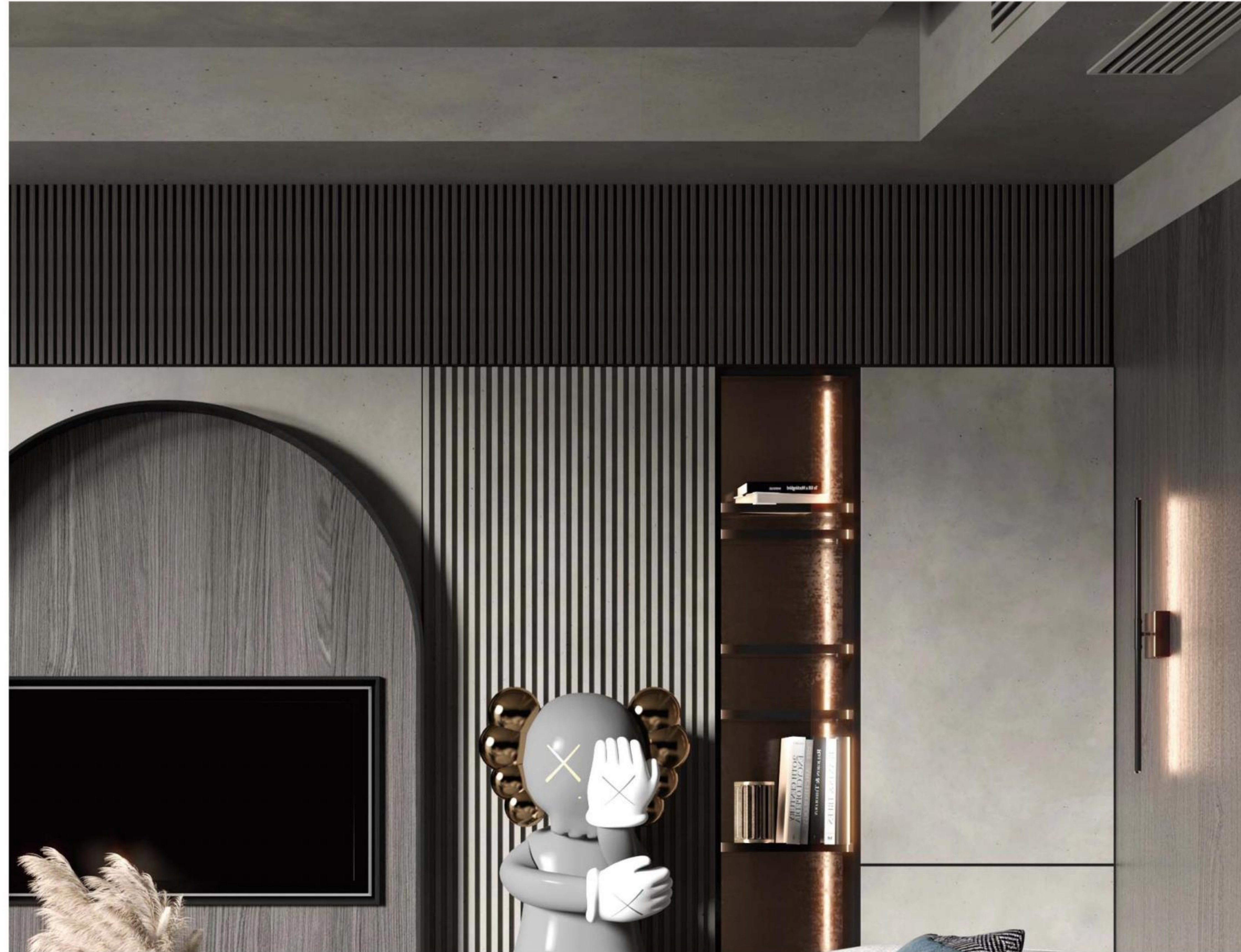

CSW-15017

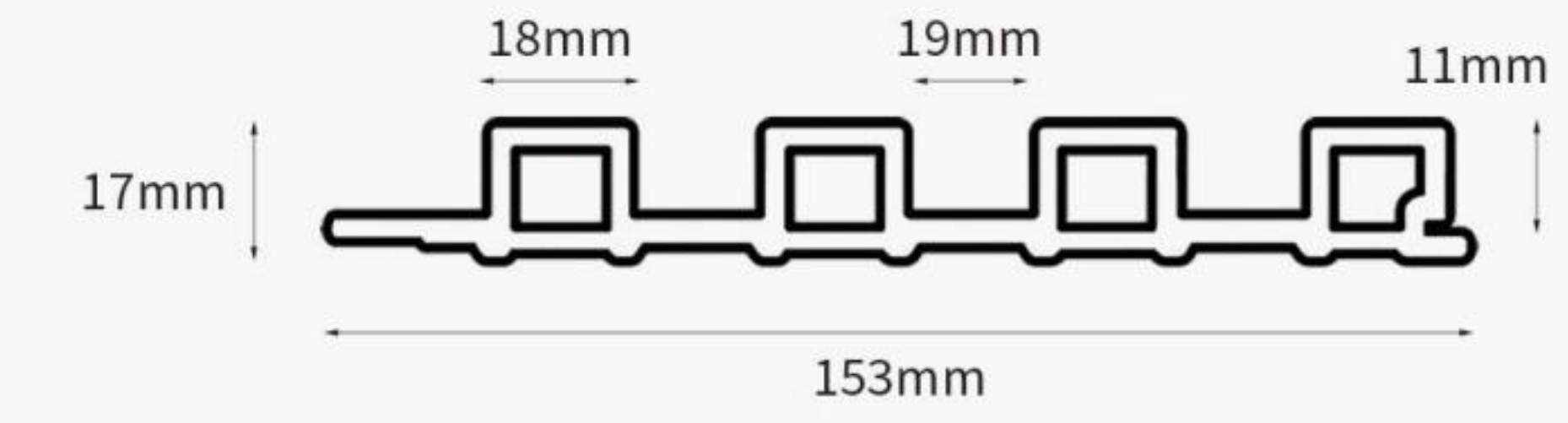

CSW-16024

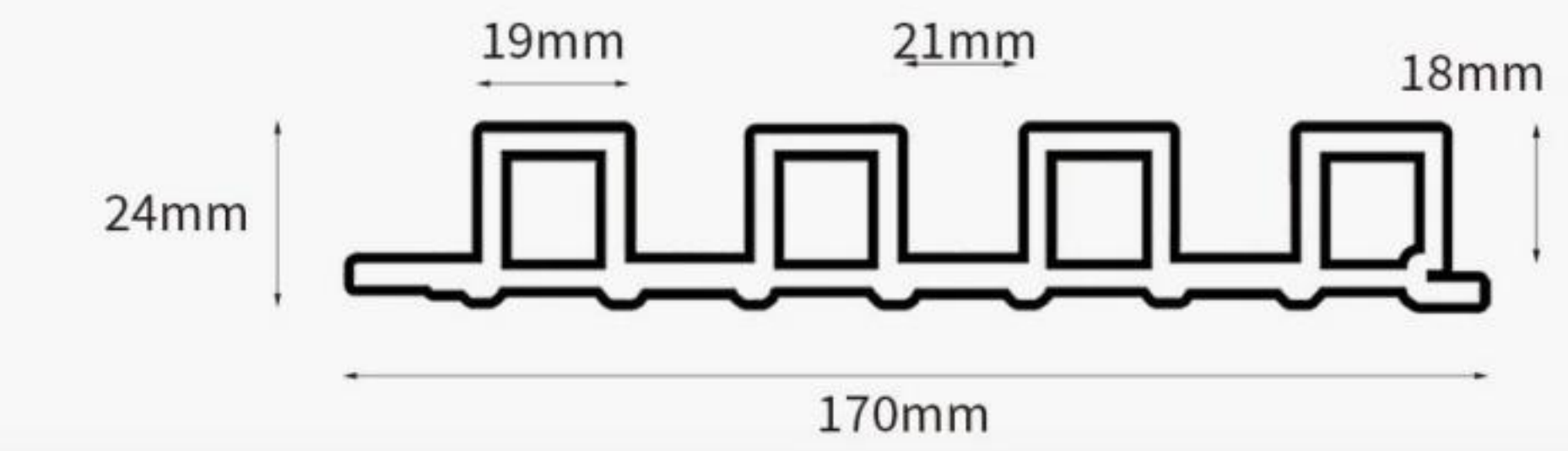

CSW-16018

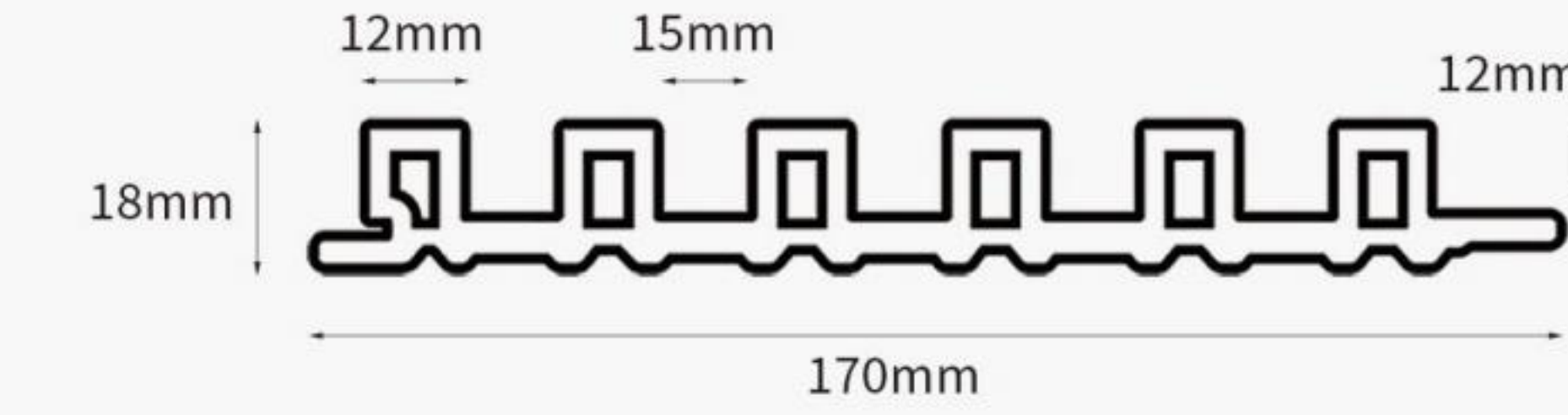

CSW-20020

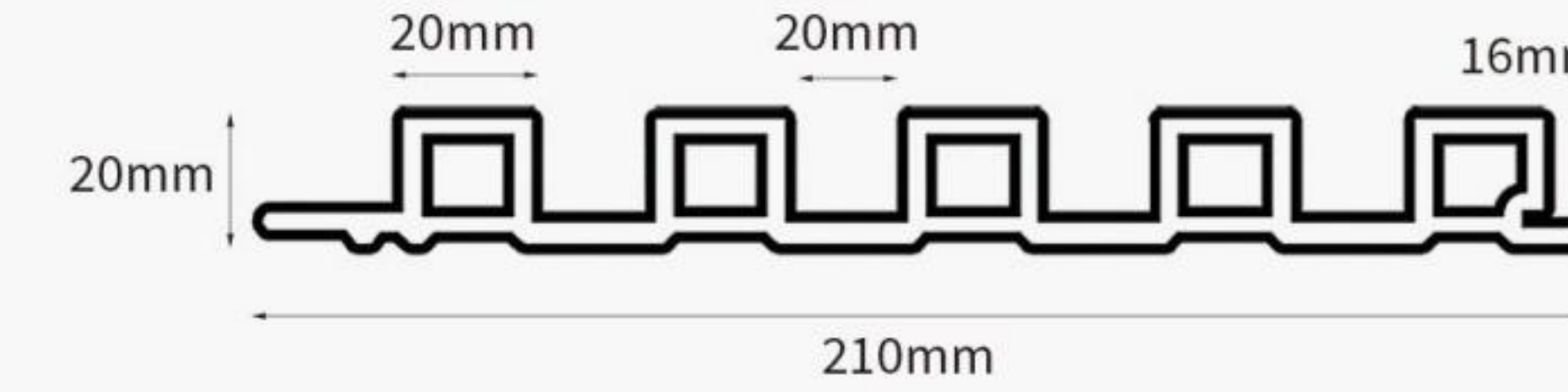

CSW-15015BY

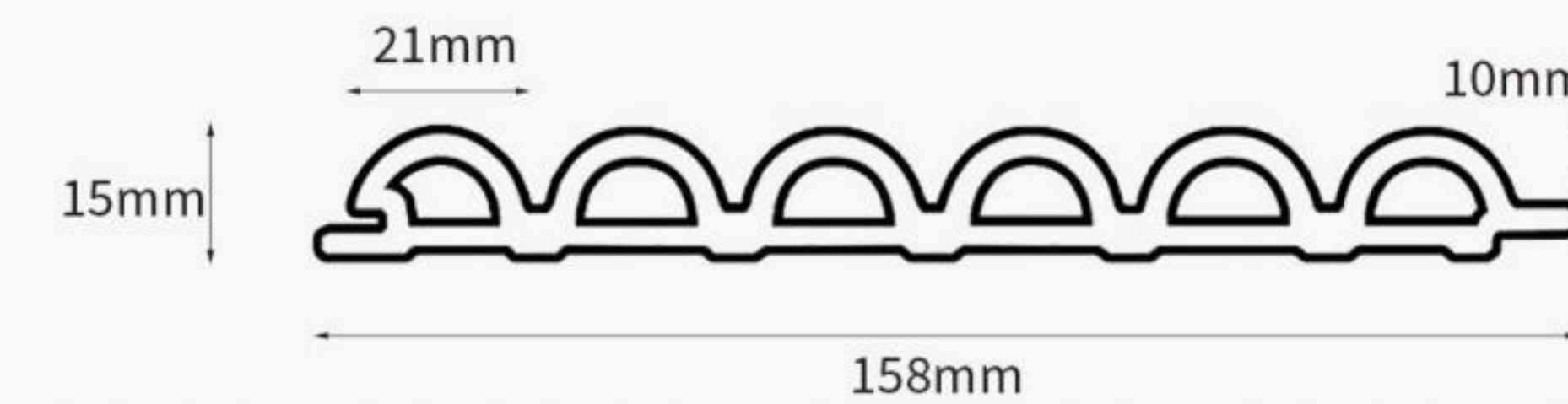

CSW-15015NH

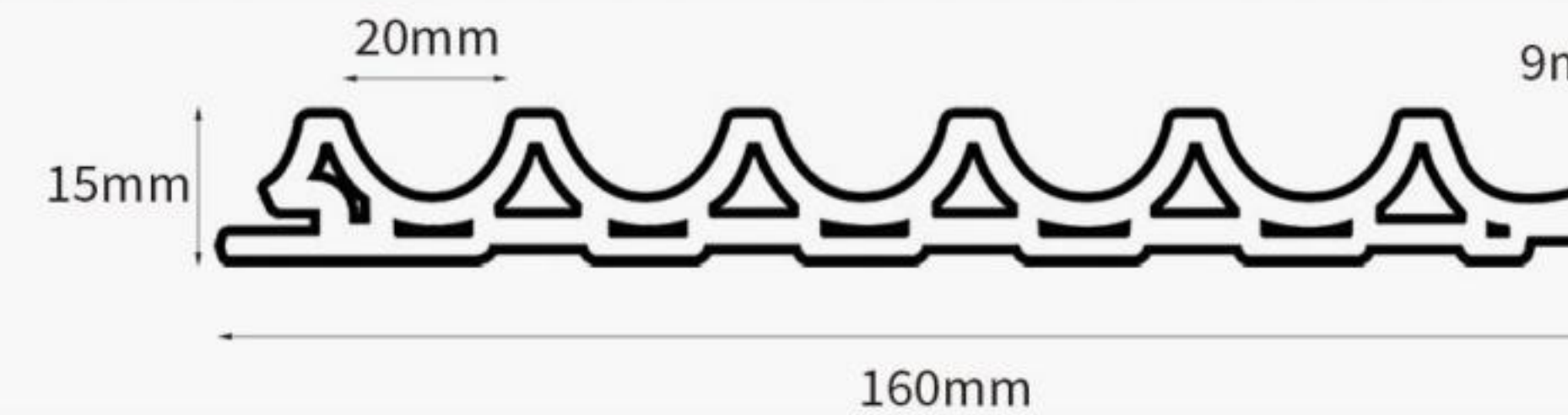

CSW-18625

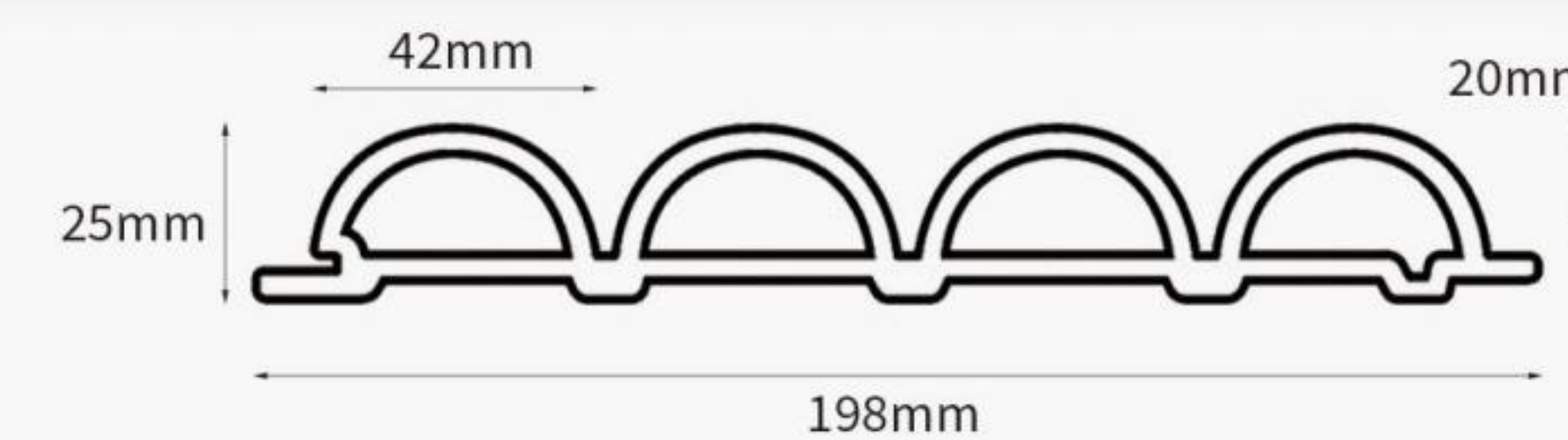

CSW-18640

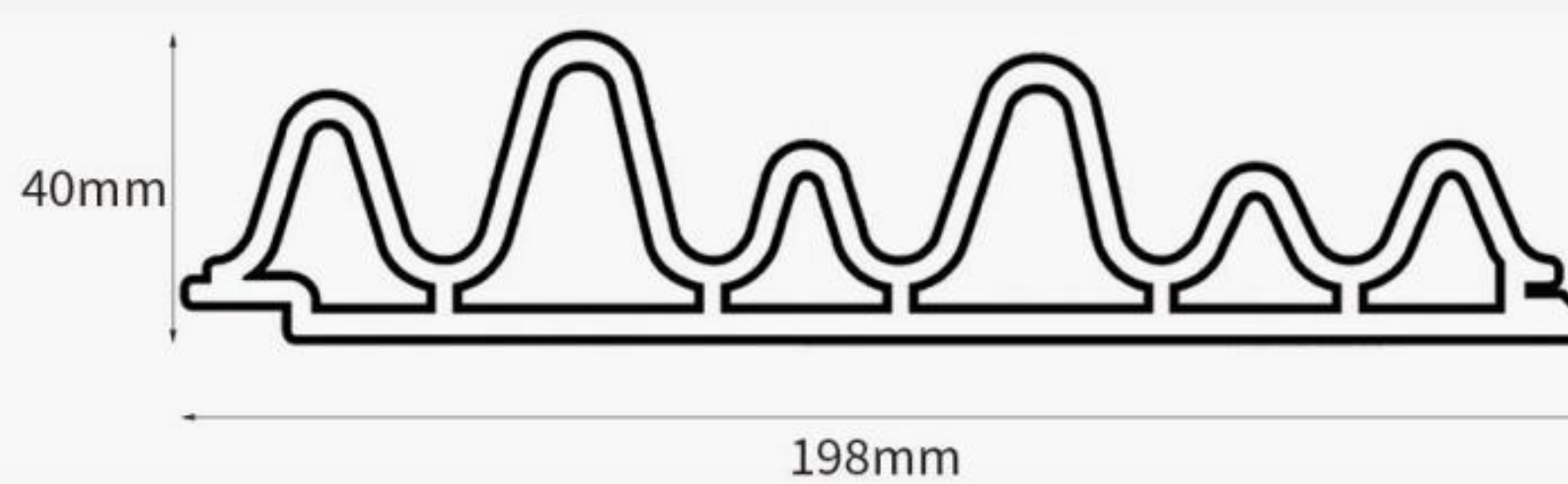

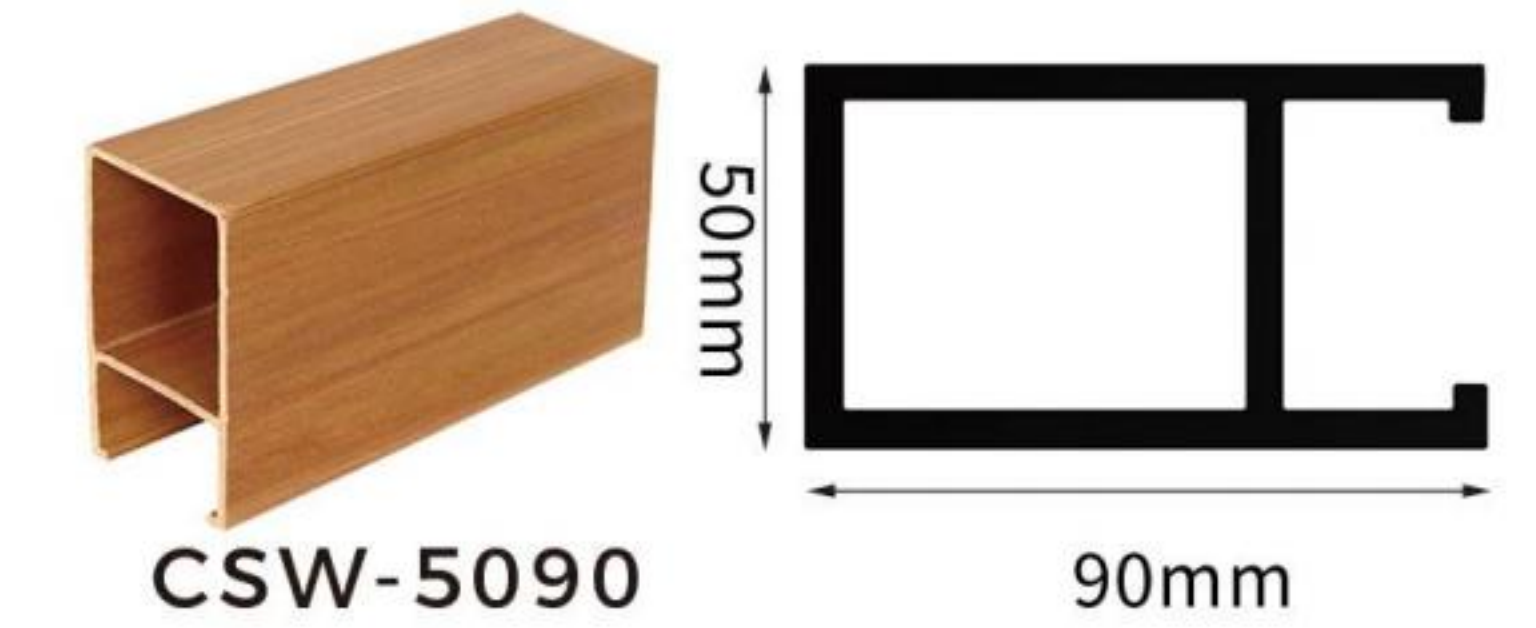
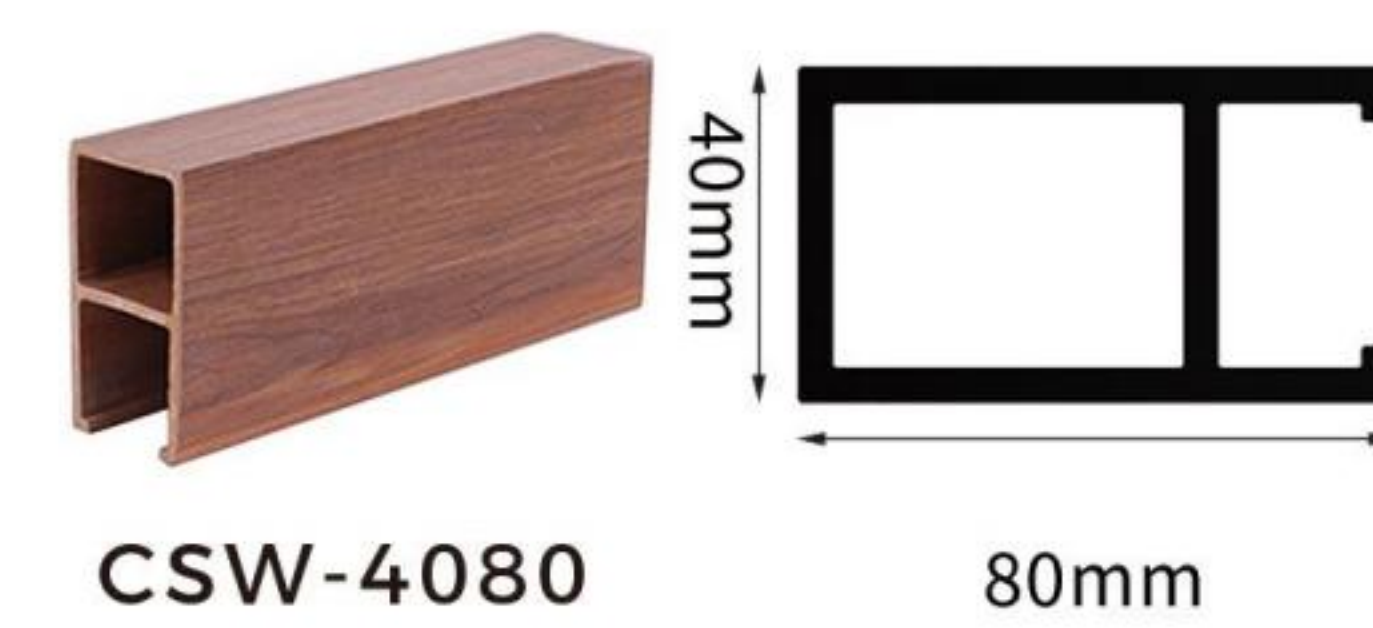
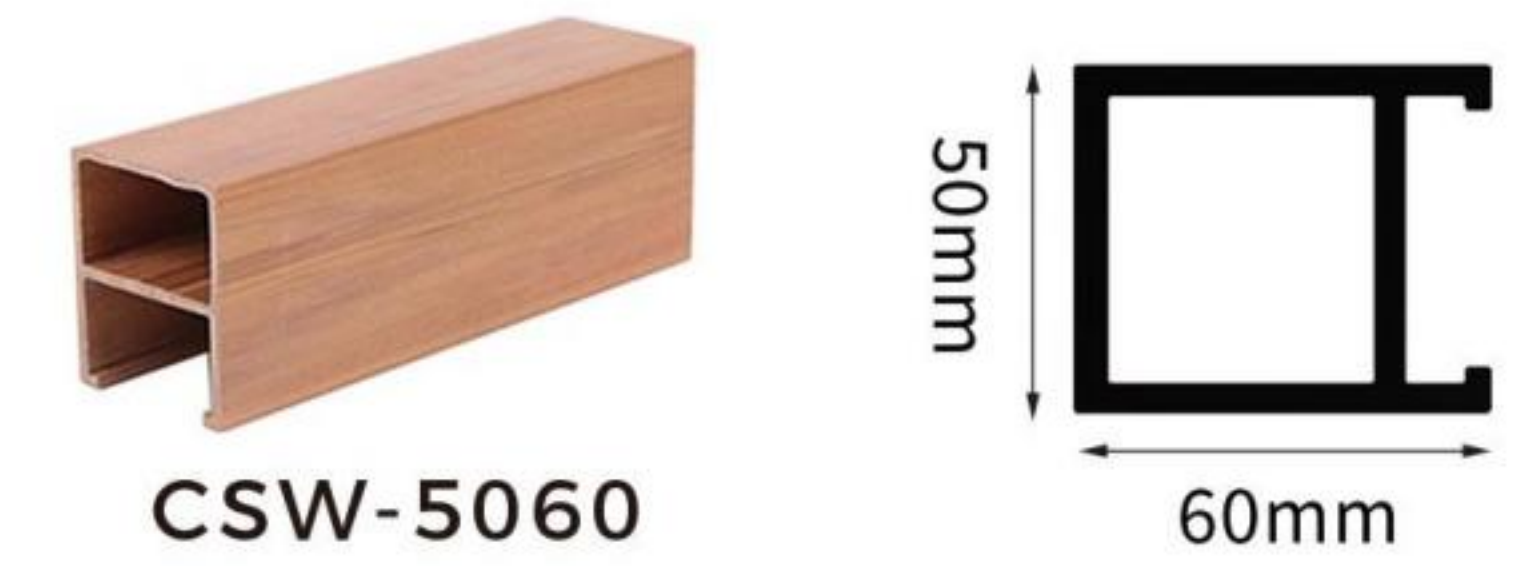
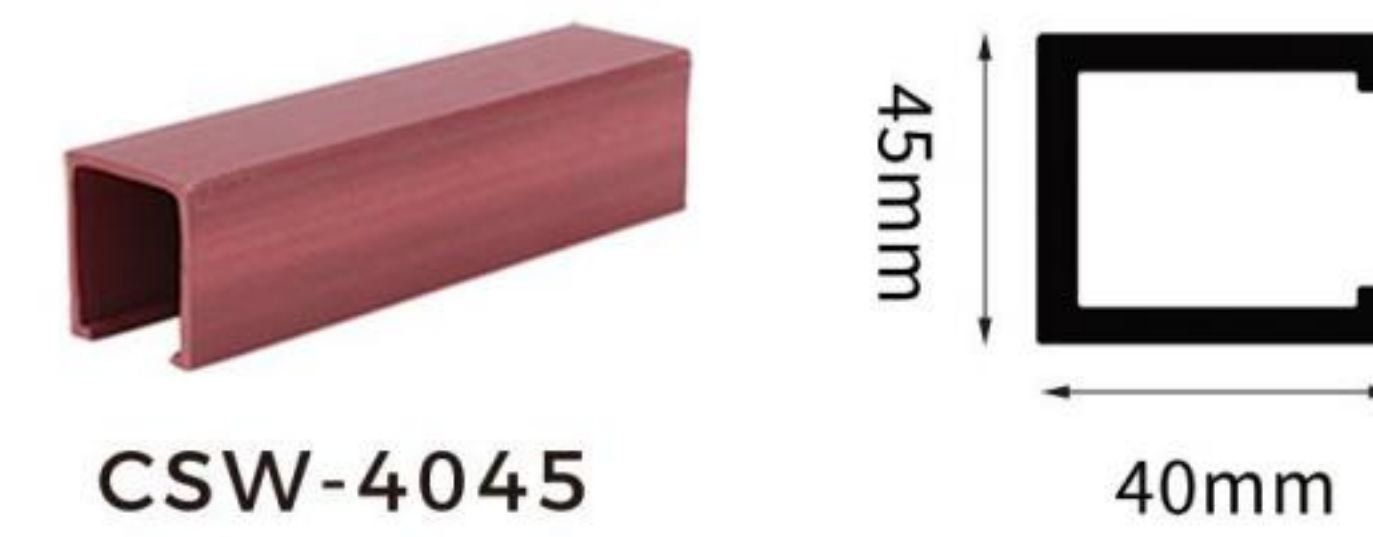
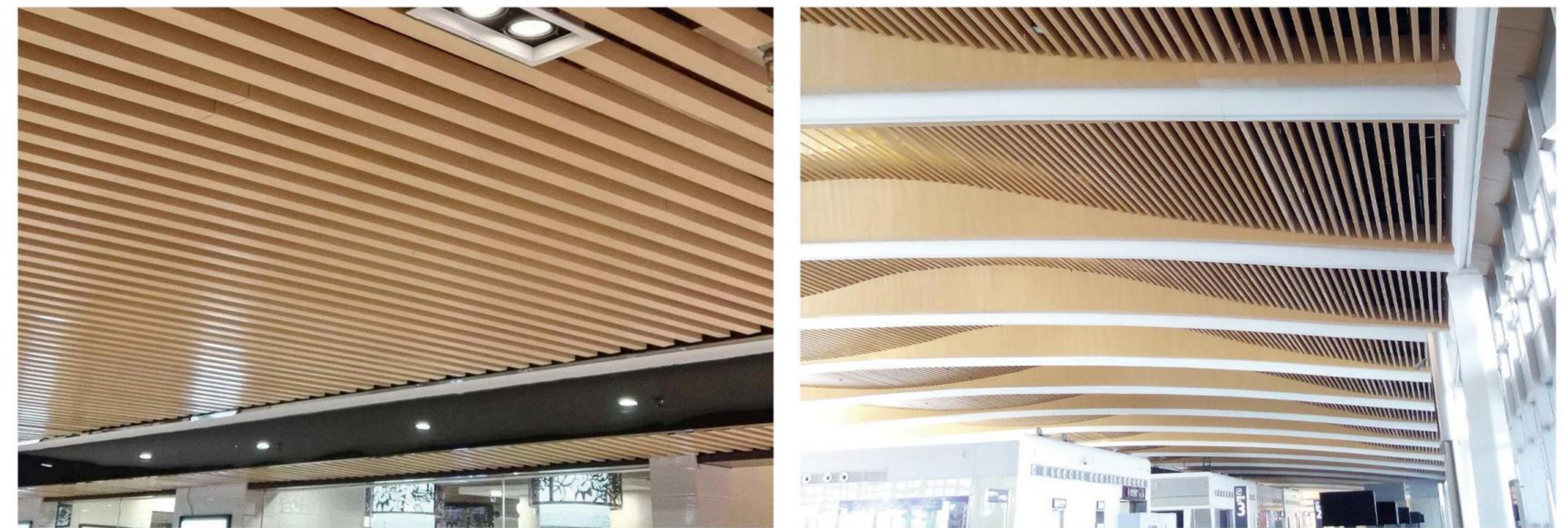
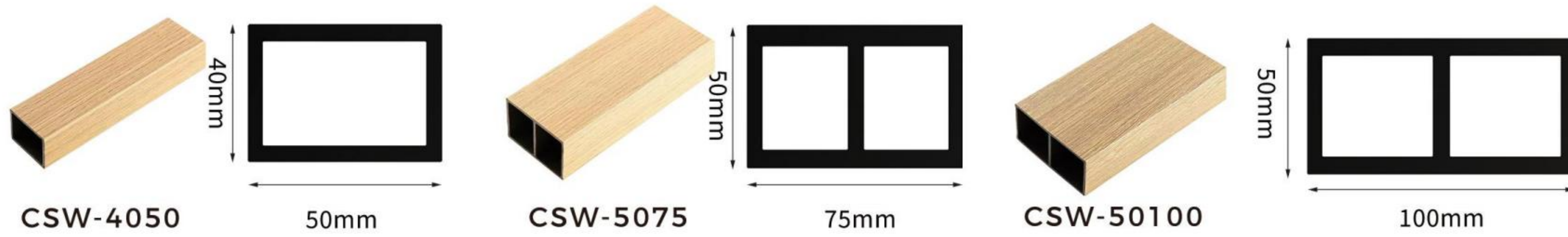
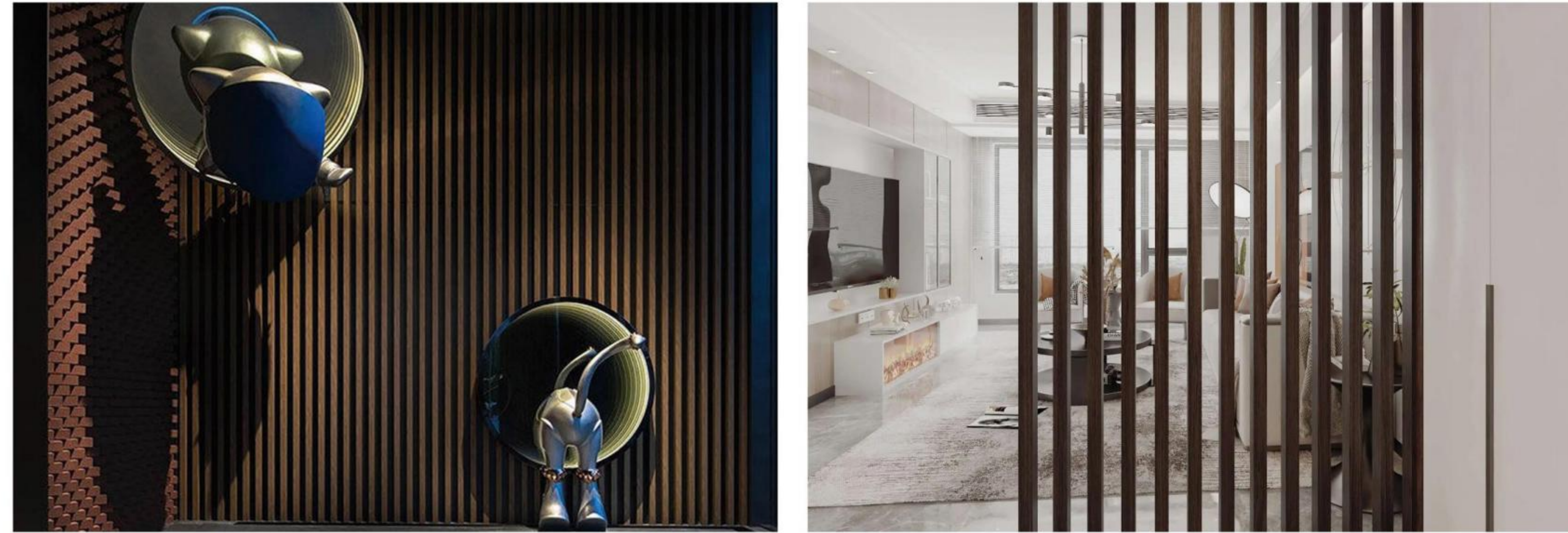

◆ VENEER SELECTION

Natural Veneer



Oak



Grey Oak



Smoked Oak



Walnut

Tech Veneer



Tech Oak



Tech Grey Oak



Tech W. Oak



Tech Smoked Oak



Tech Walnut



Tech Walnut JK



Tech Black

Melamine Veneer



*Many colors are available

◆ MDF SELECTION



Yellow Pine Board

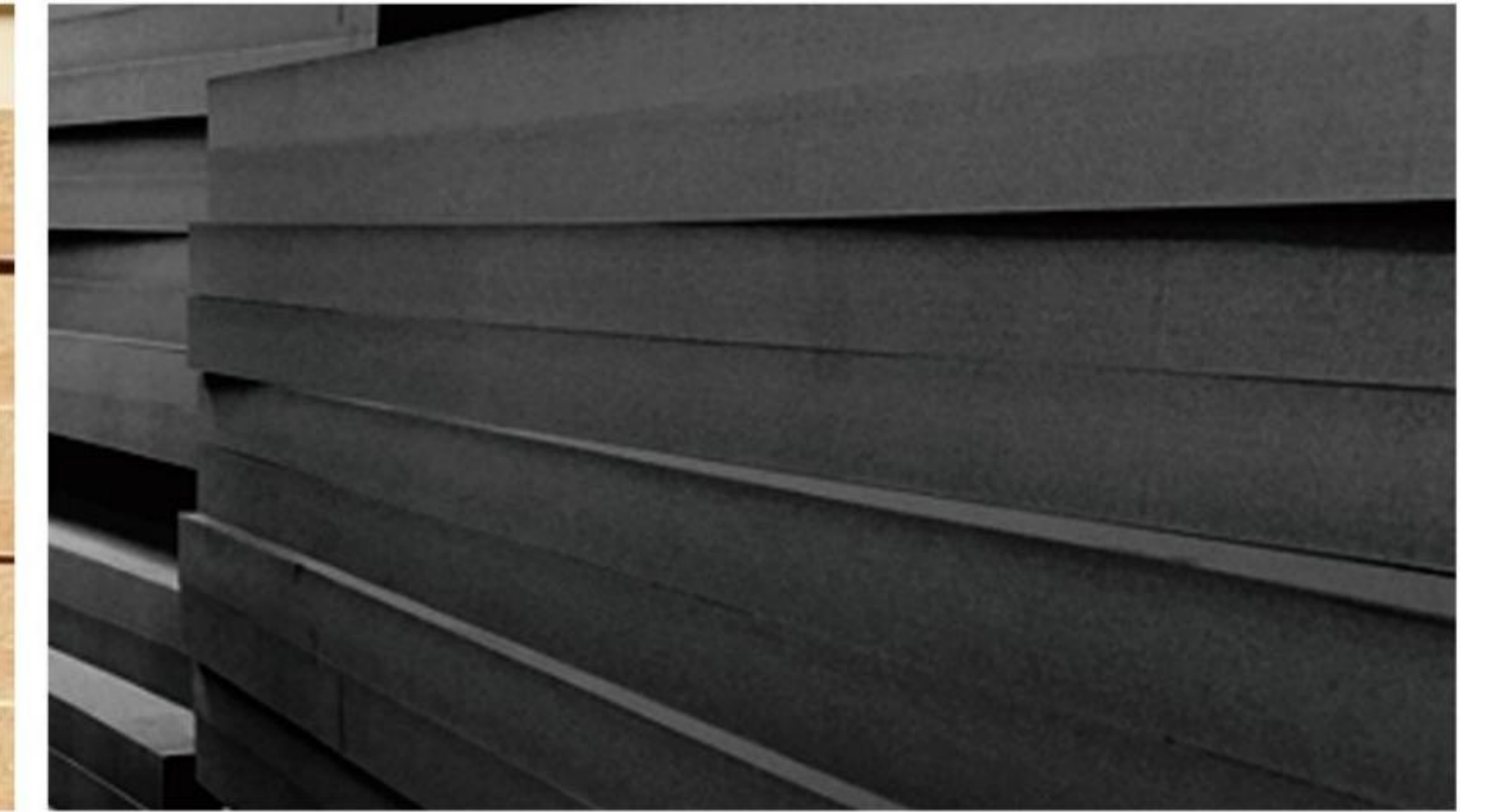

Black MDF

◆ PET COLOR SELECTION



Grey

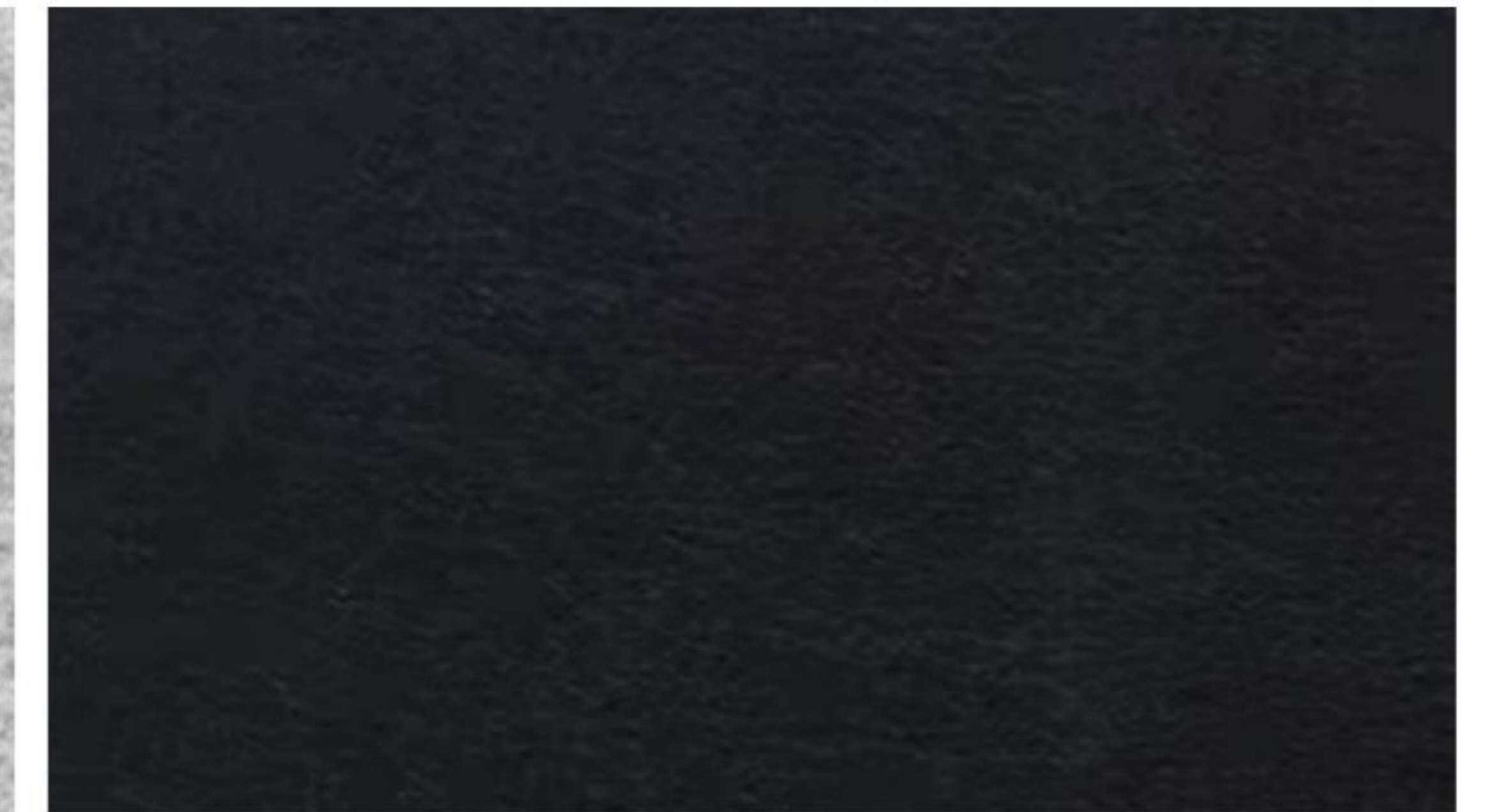

Black

◆ PACKING



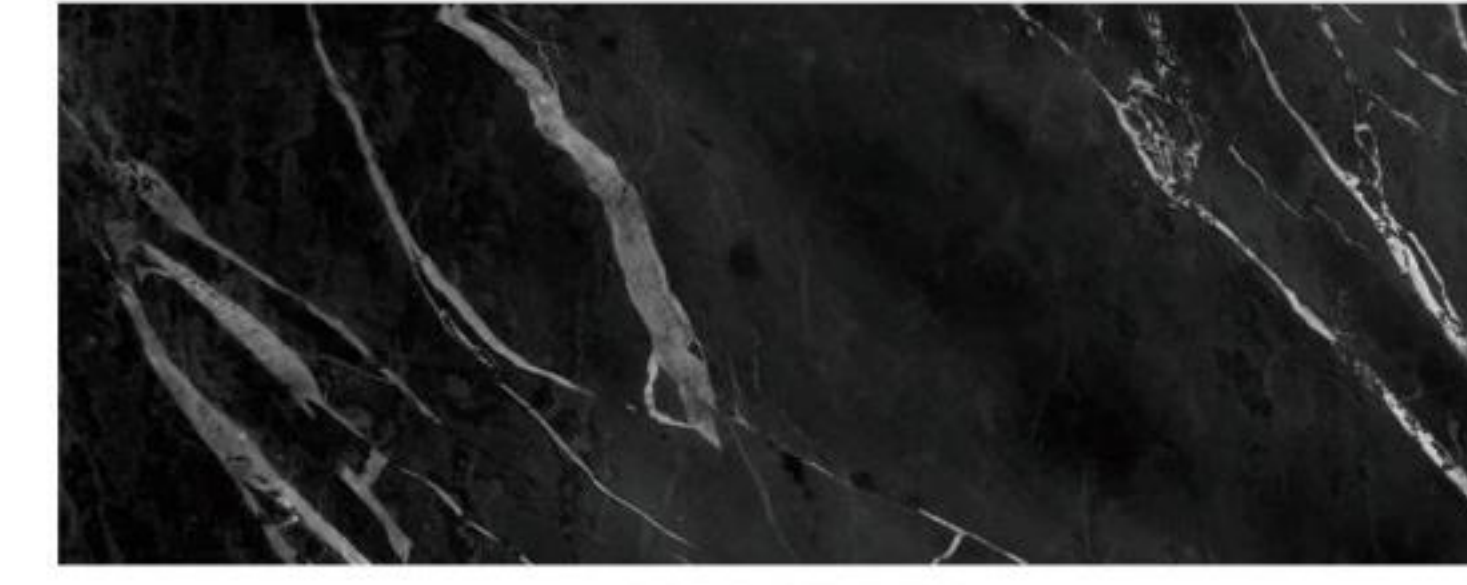
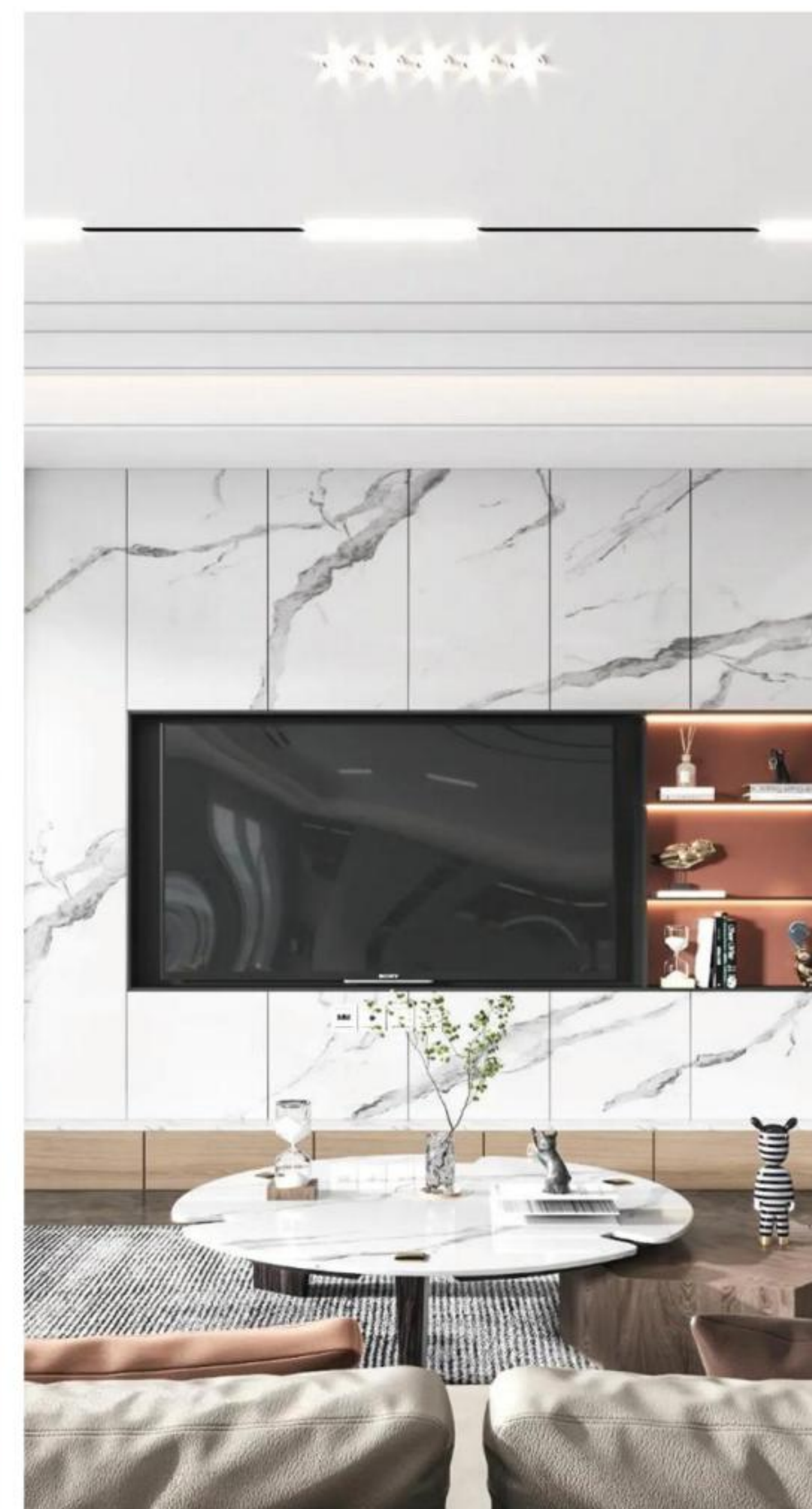

CSU-51001

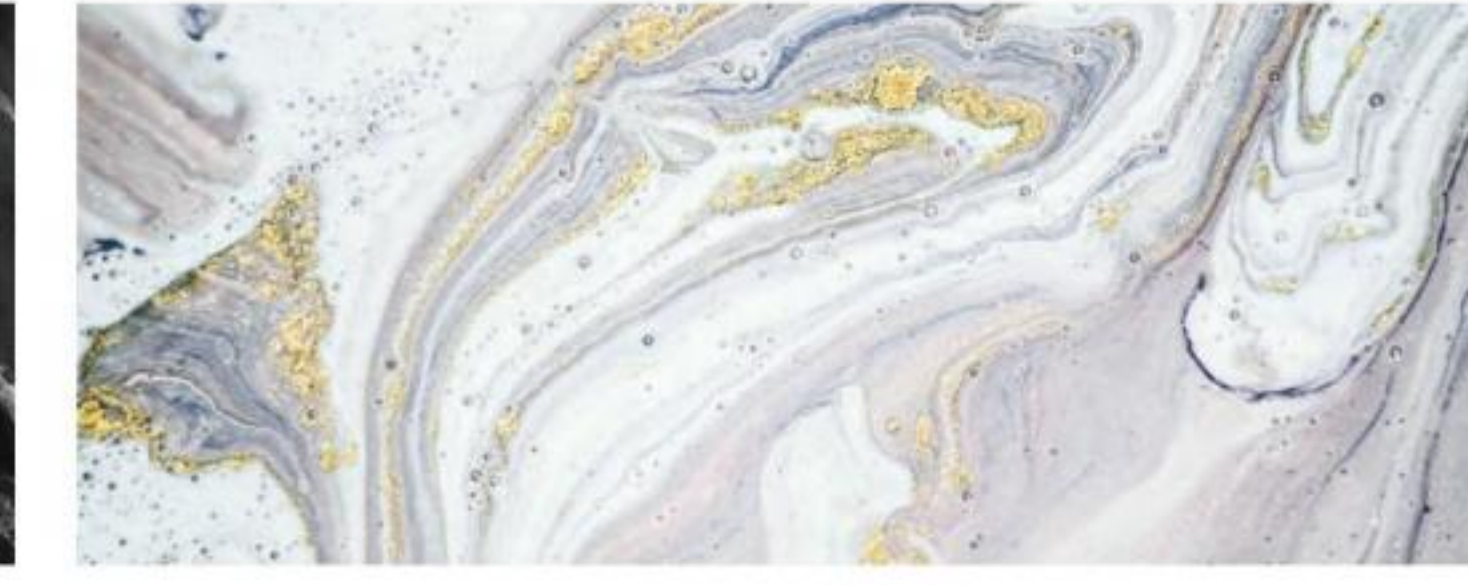

CSU-51002

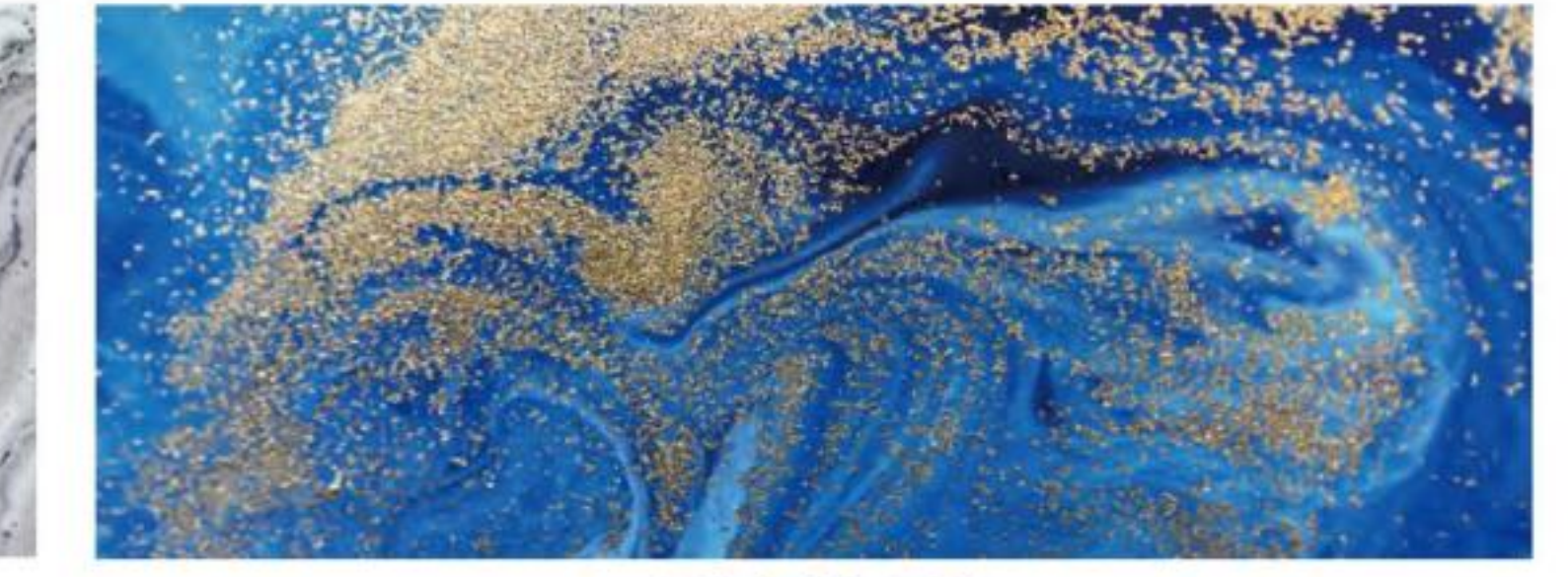

CSU-51003



CSU-51004

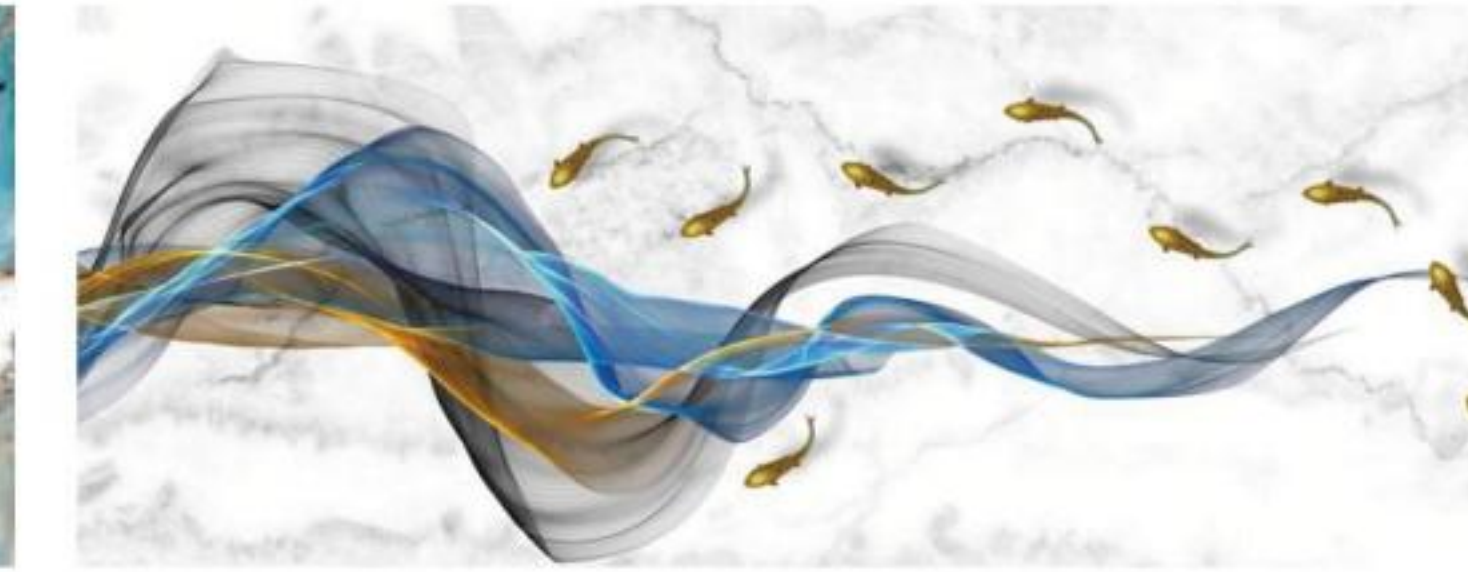

CSU-51005



CSU-51006



CSU-51007



CSU-51008

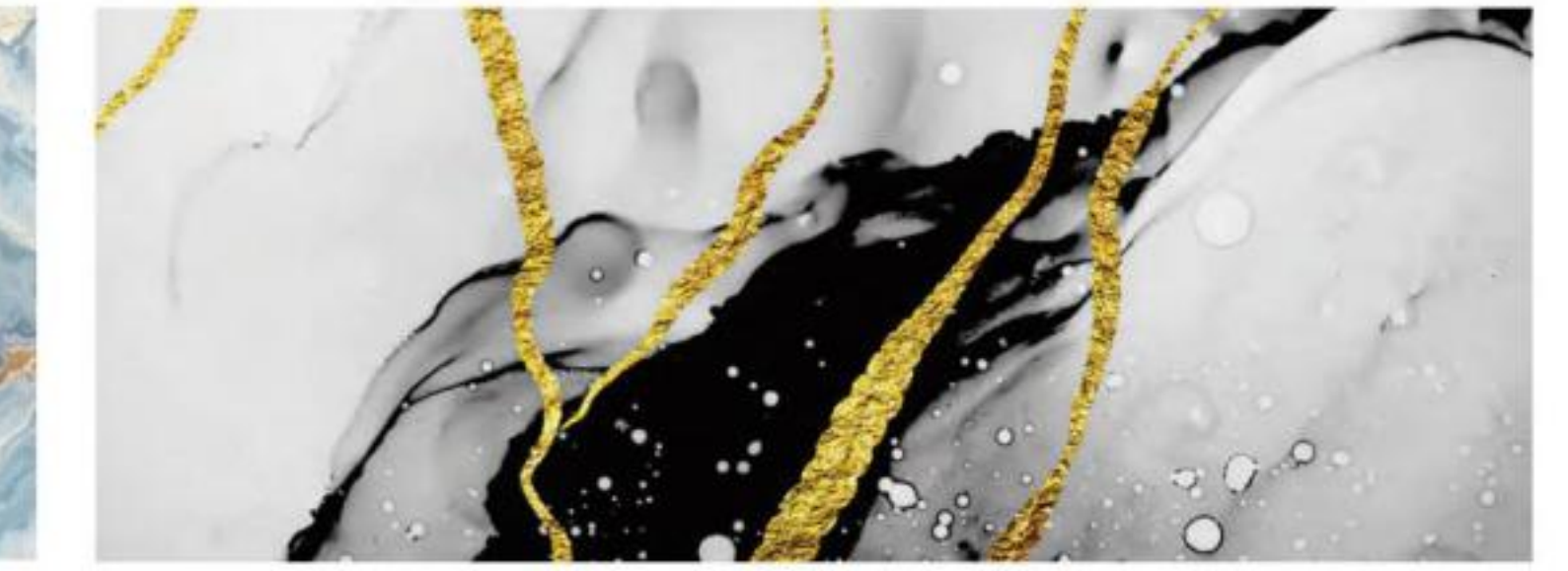

CSU-51009

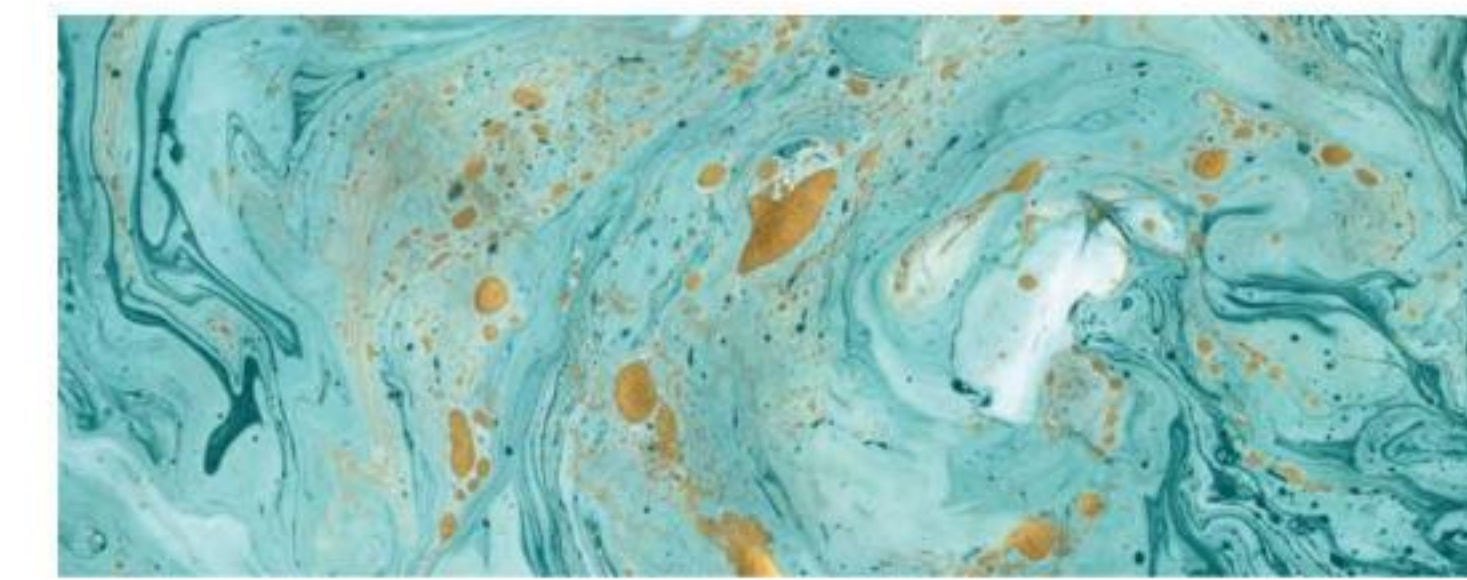

CSU-51010

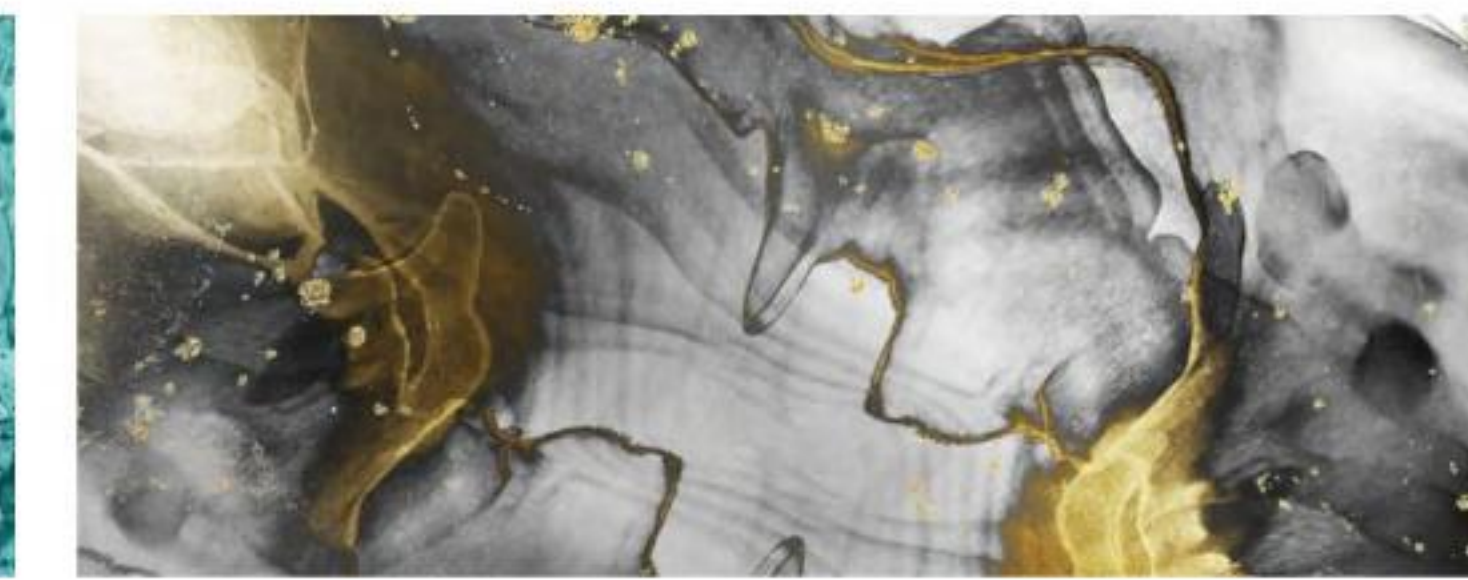

CSU-51011



CSU-51012

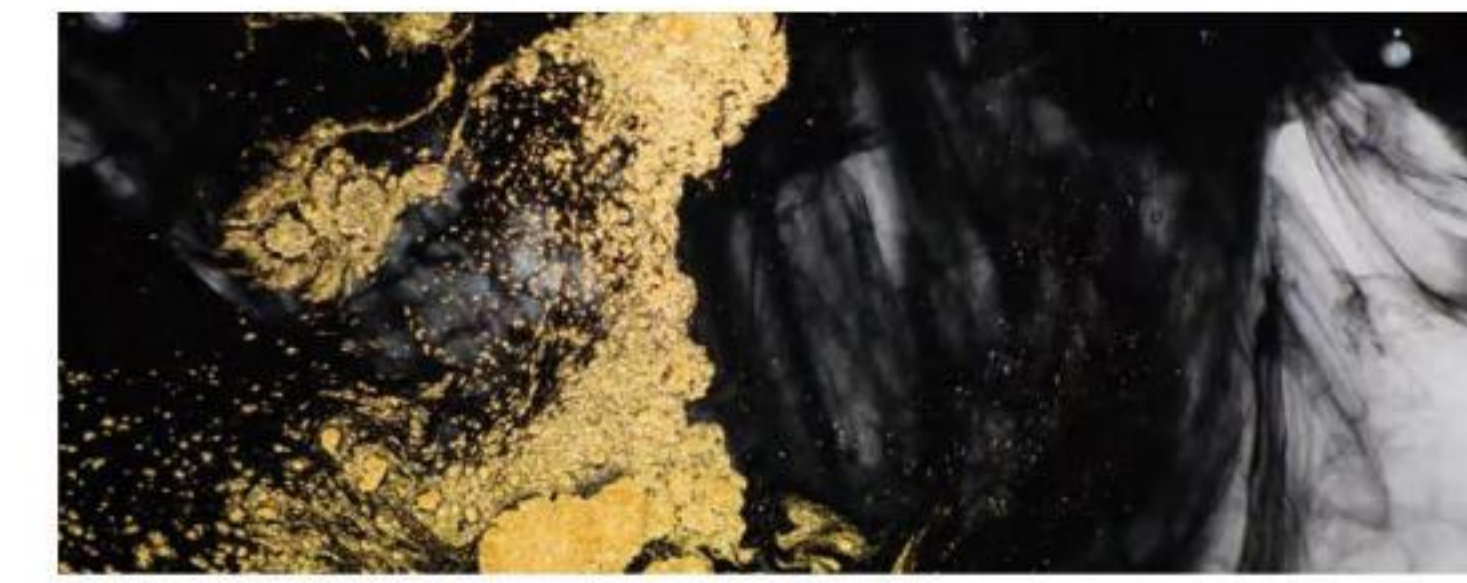

CSU-51013



CSU-51014



CSU-51015

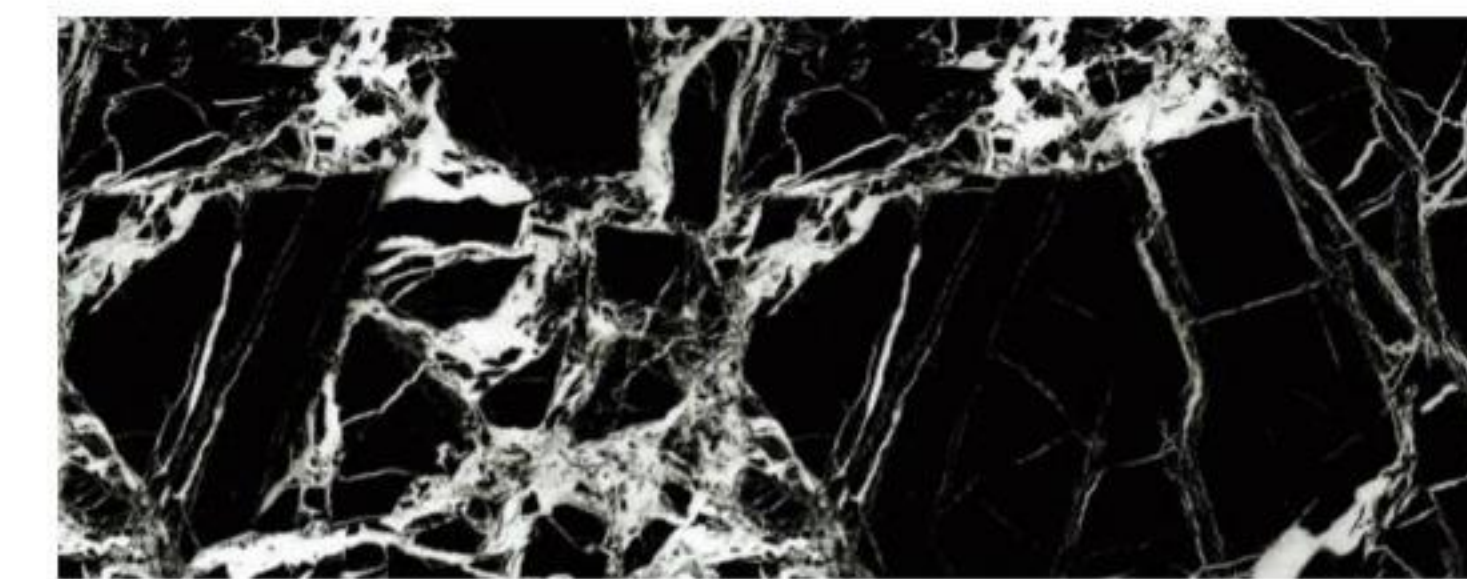

CSU-51016



CSU-51017

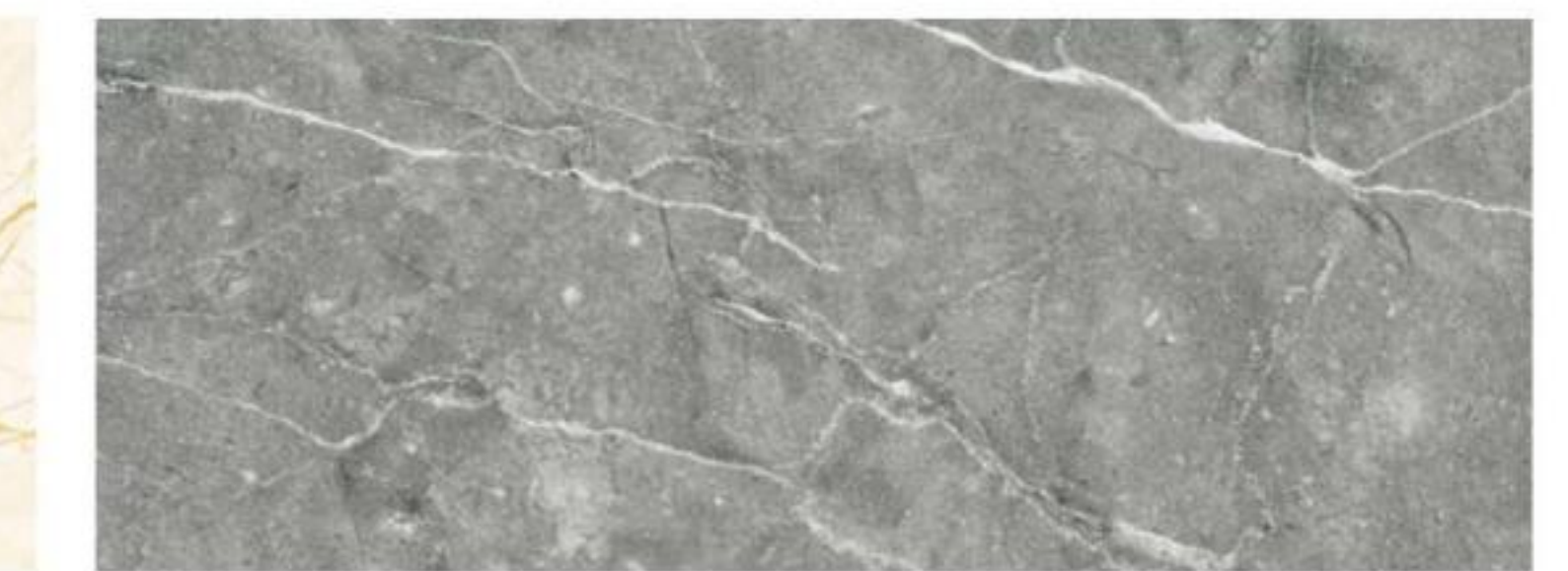

CSU-51018



CSU-51019



CSU-51020



CSU-51021



CSU-51022



CSU-51023



CSU-51024

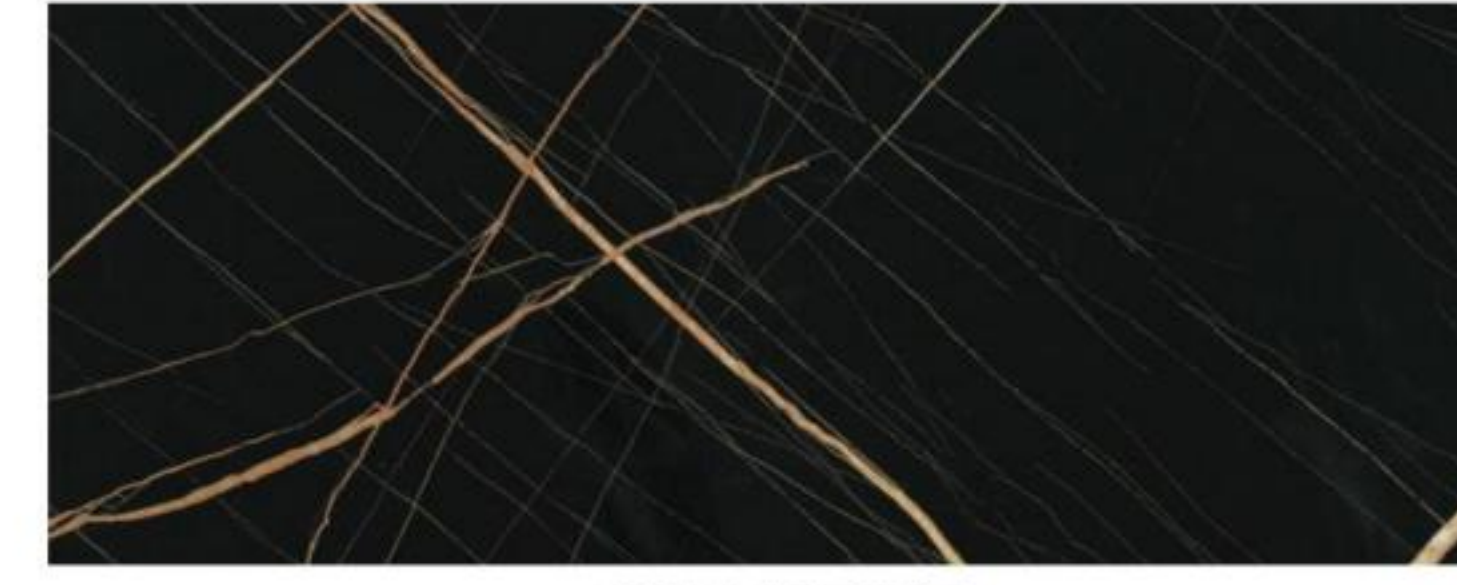

CSU-51025

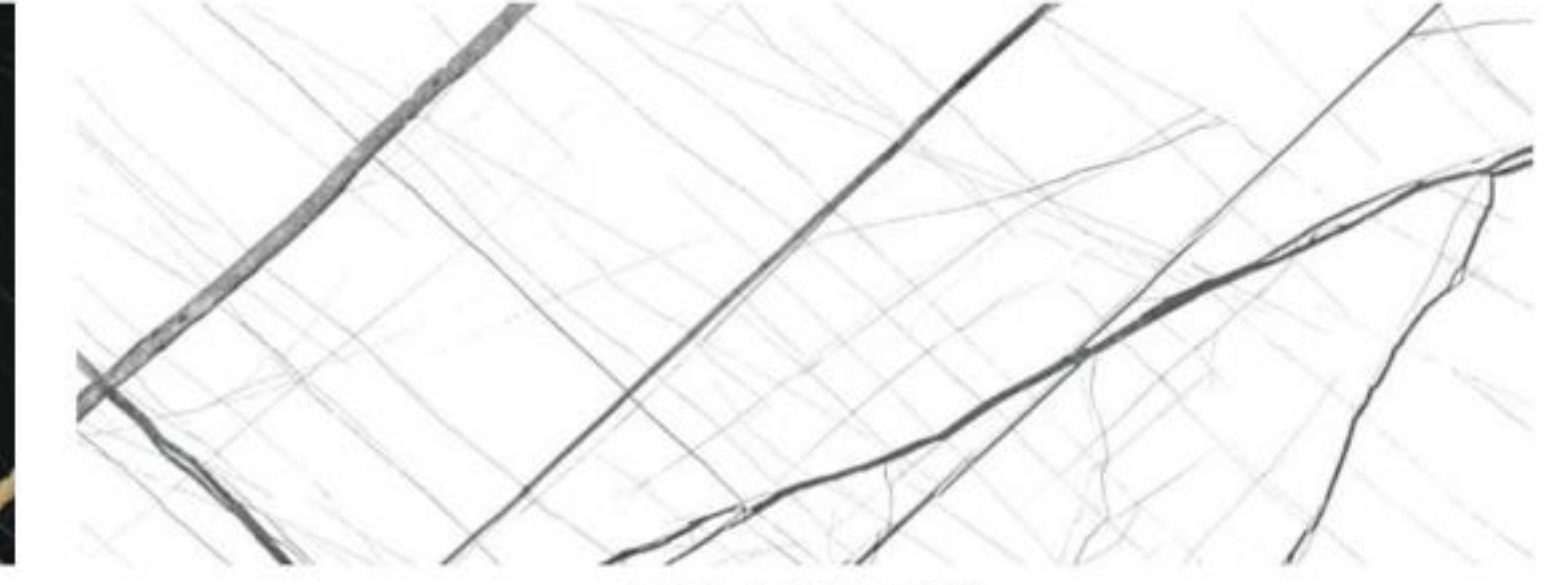

CSU-51026

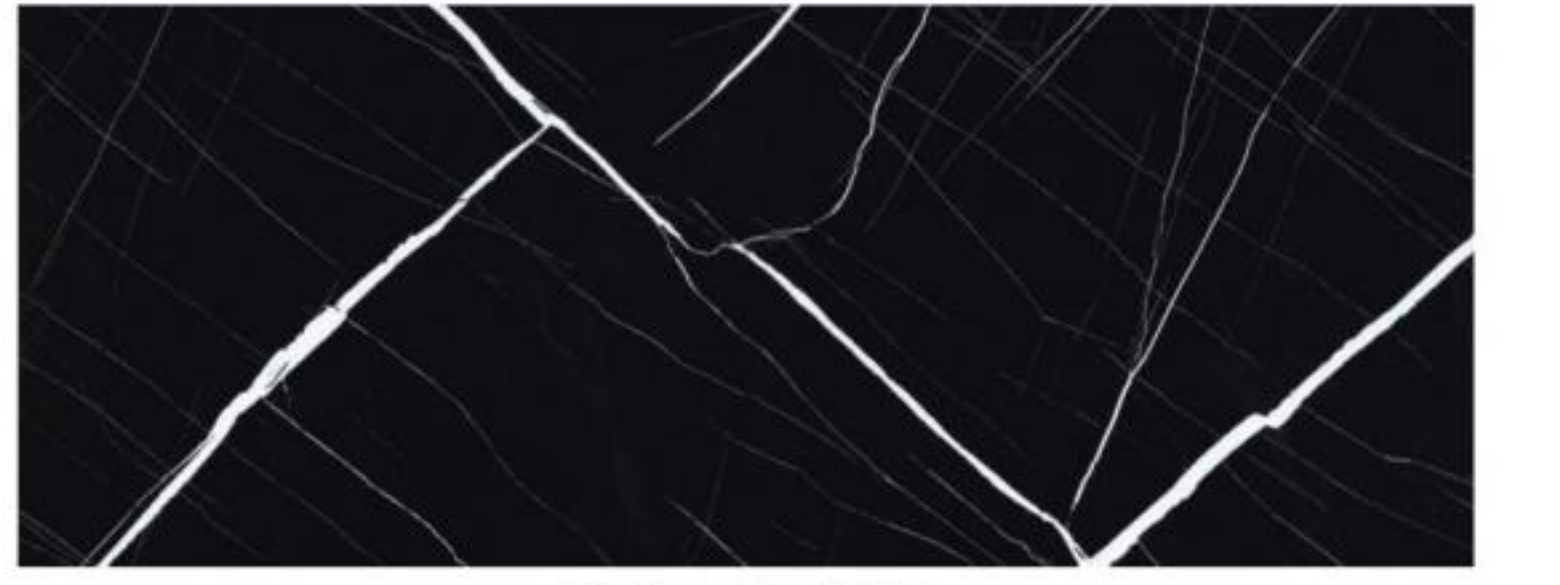

CSU-51027

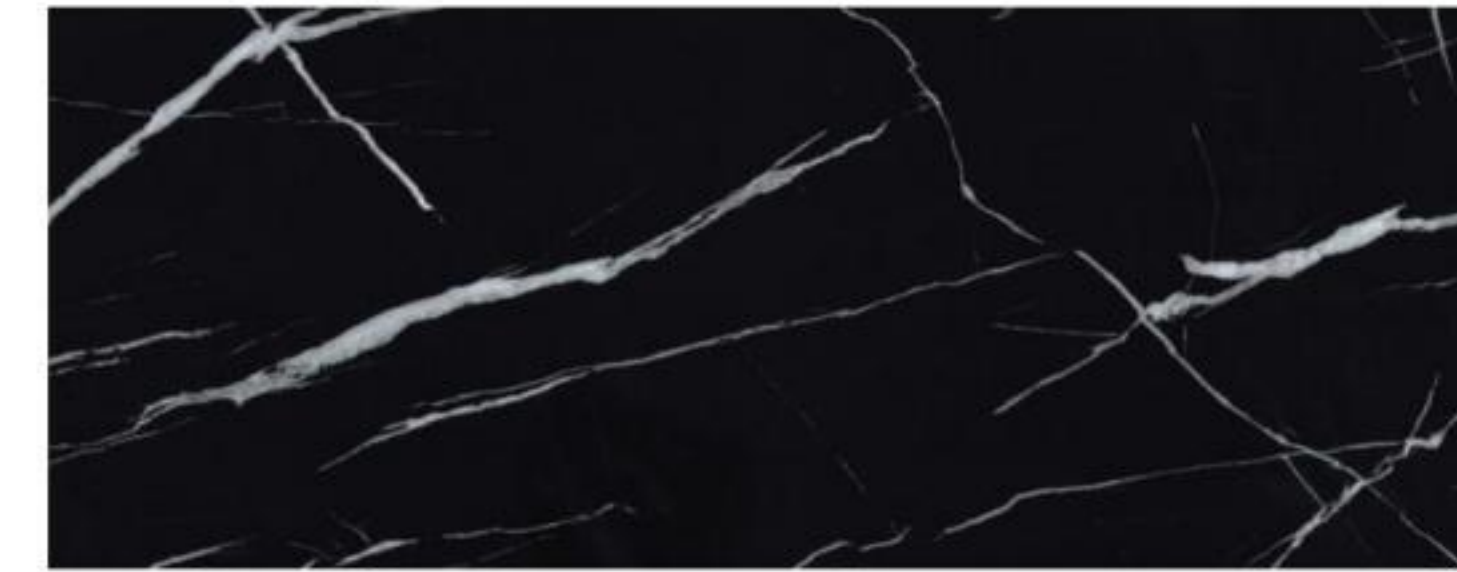

CSU-51028

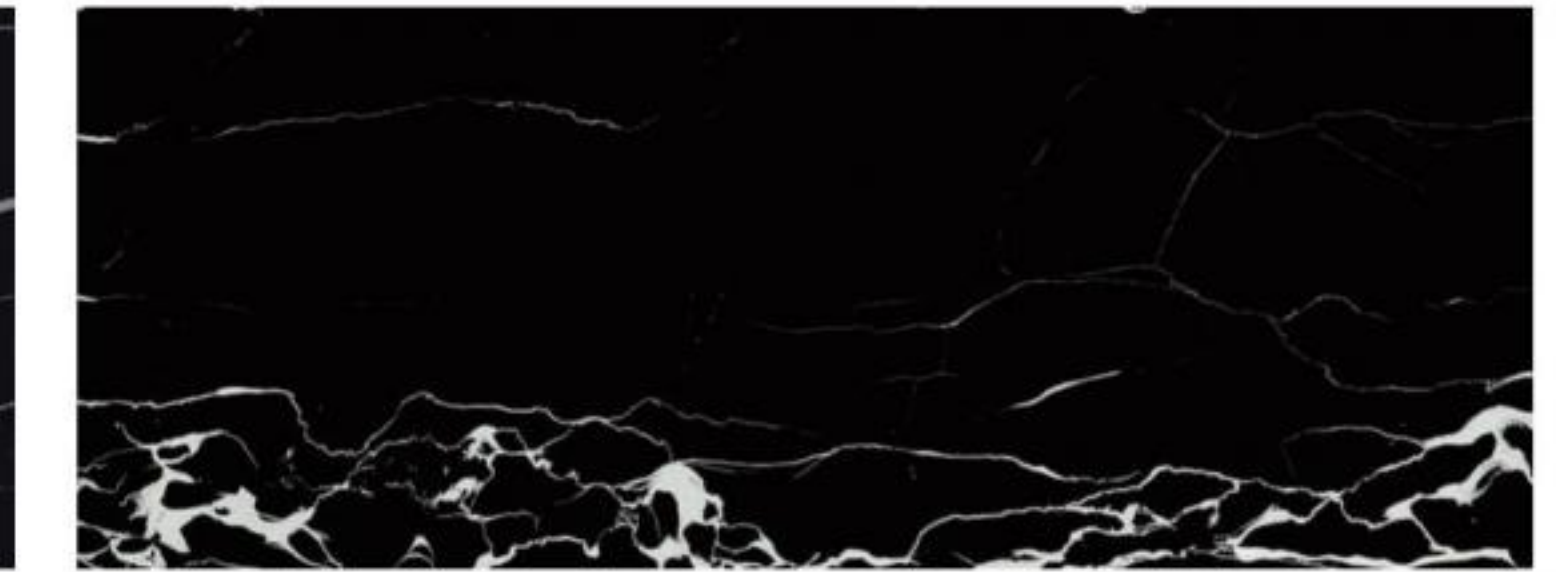

CSU-51029

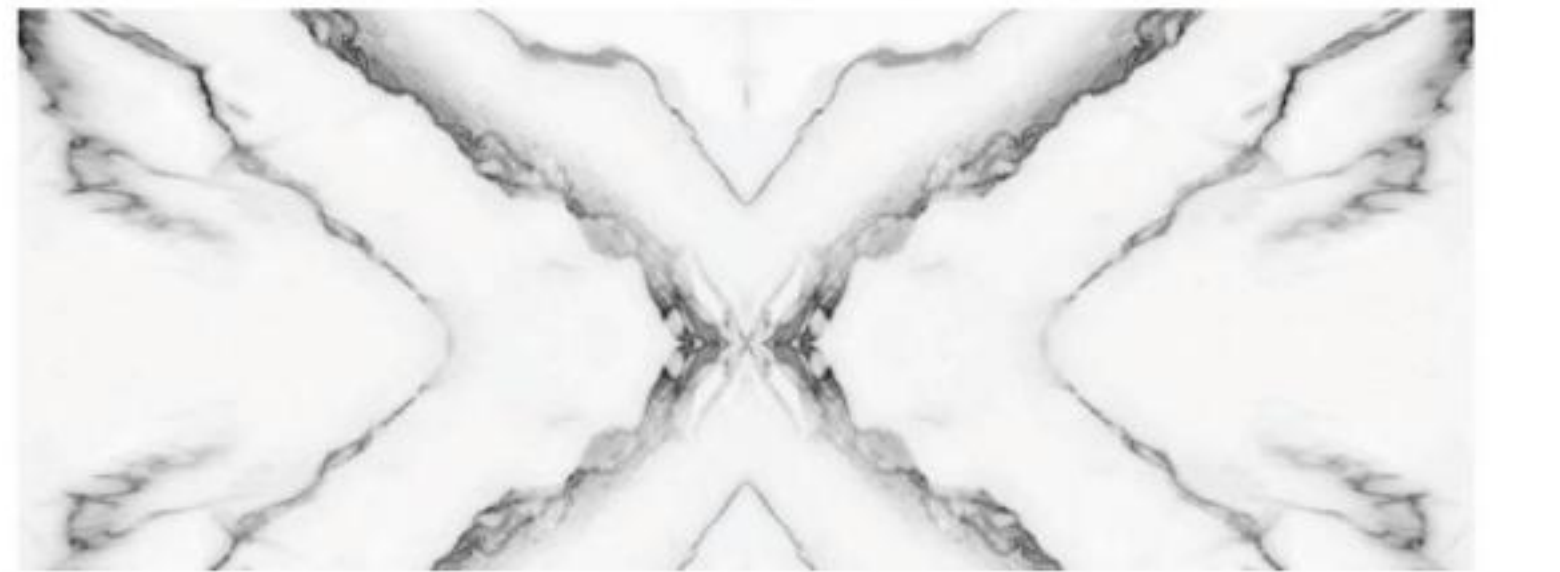

CSU-51030



CSU-51031

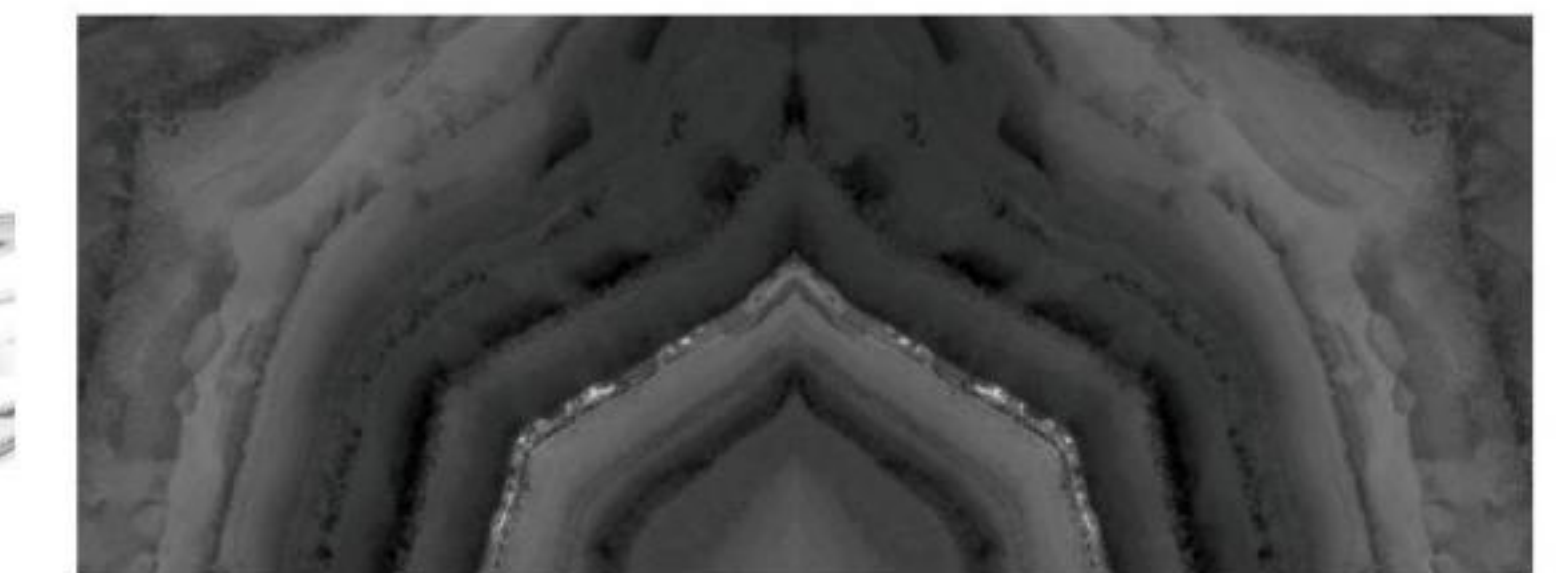

CSU-51032



CSU-51033

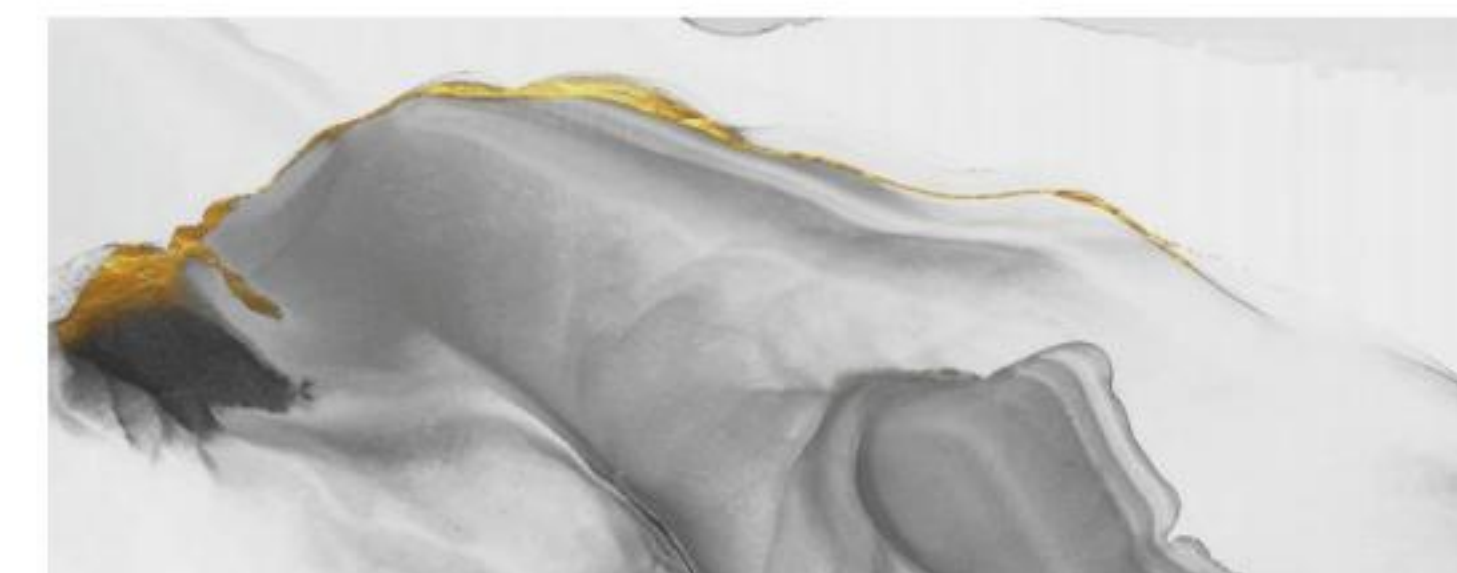

CSU-510034



CSU-51035



CSU-51036



CSU-51037



CSU-51038



CSU-51039



CSU-51040



CSU-51041



CSU-51042

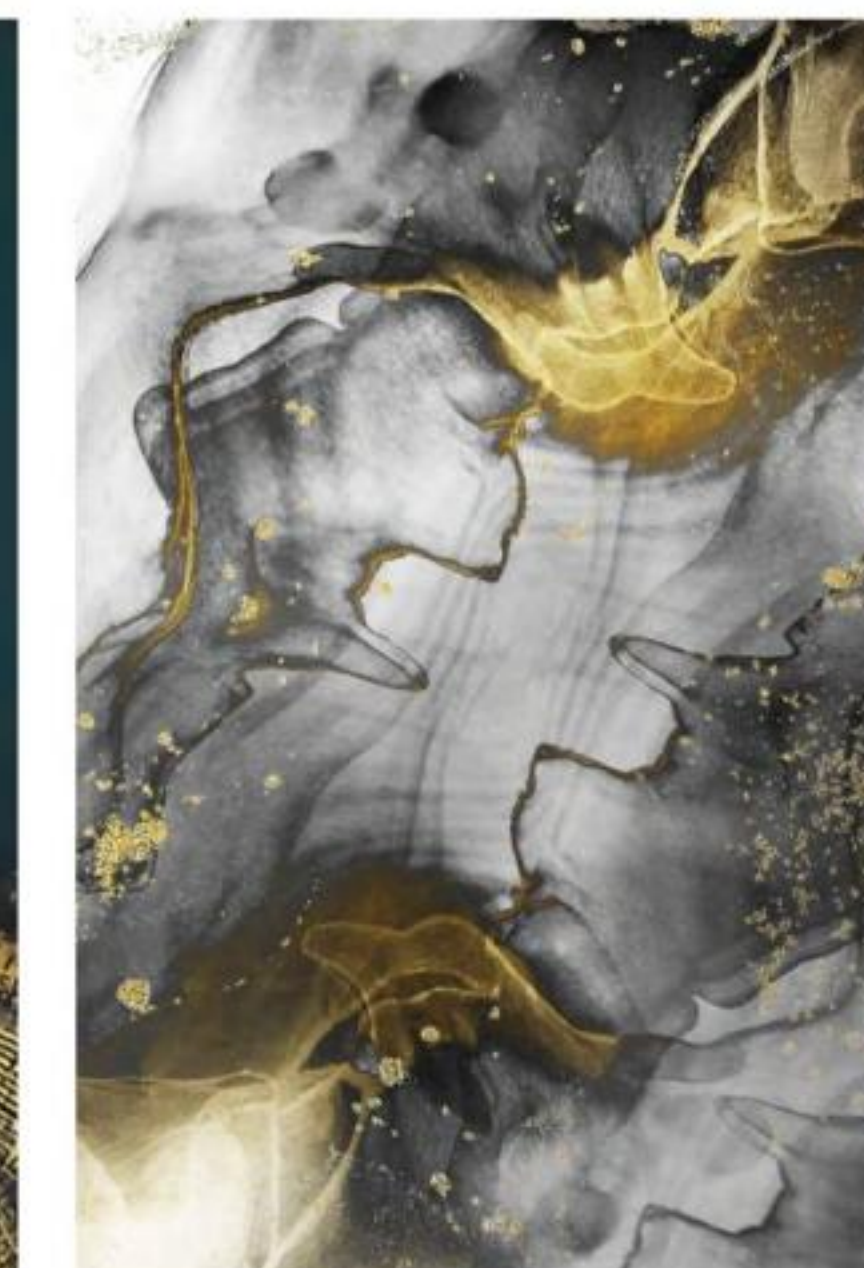

CSU-51043

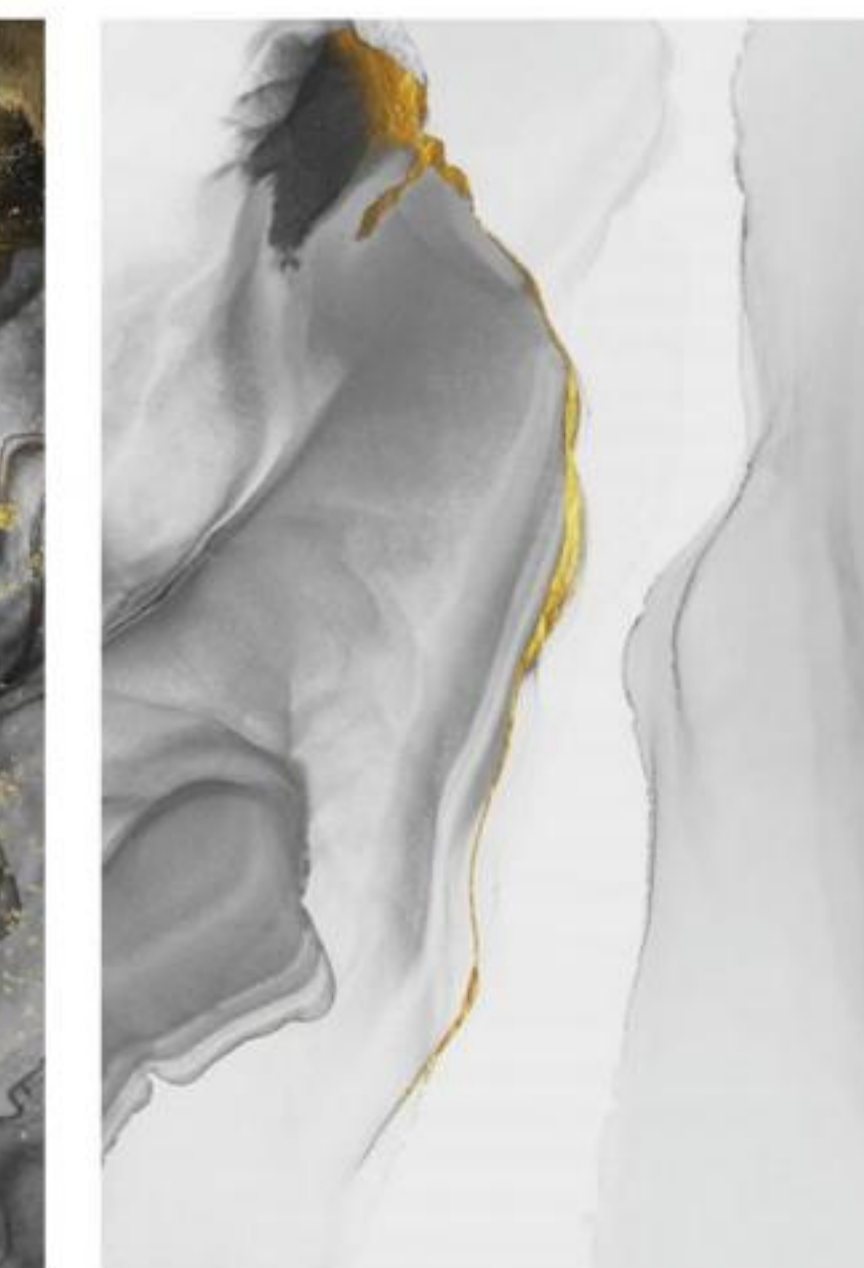

CSU-51044



CSU-51045



CSU-51046

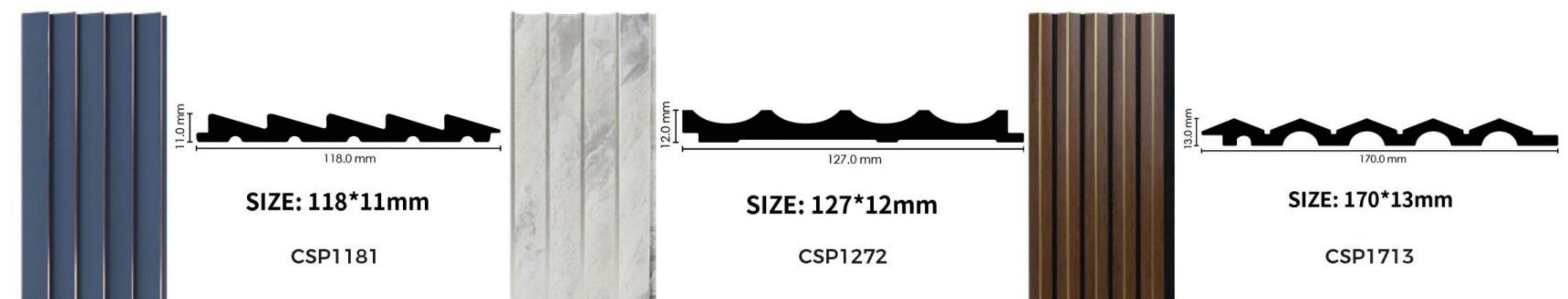
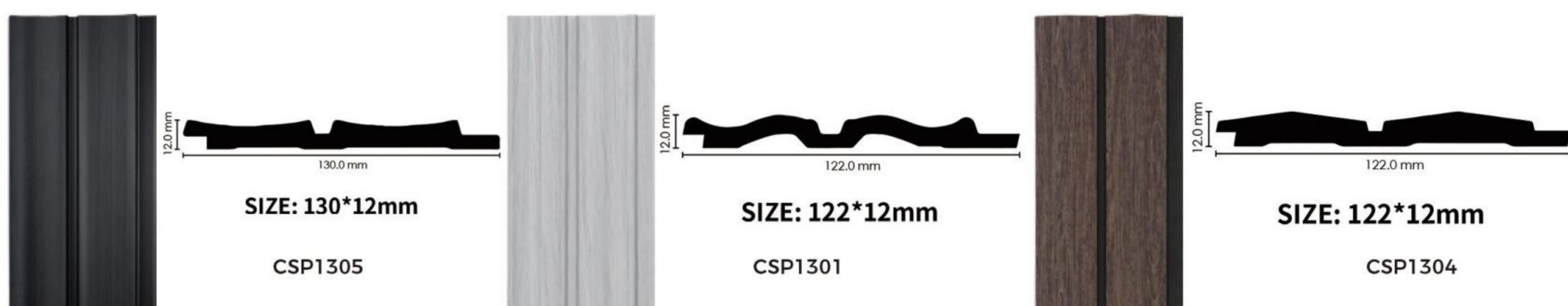
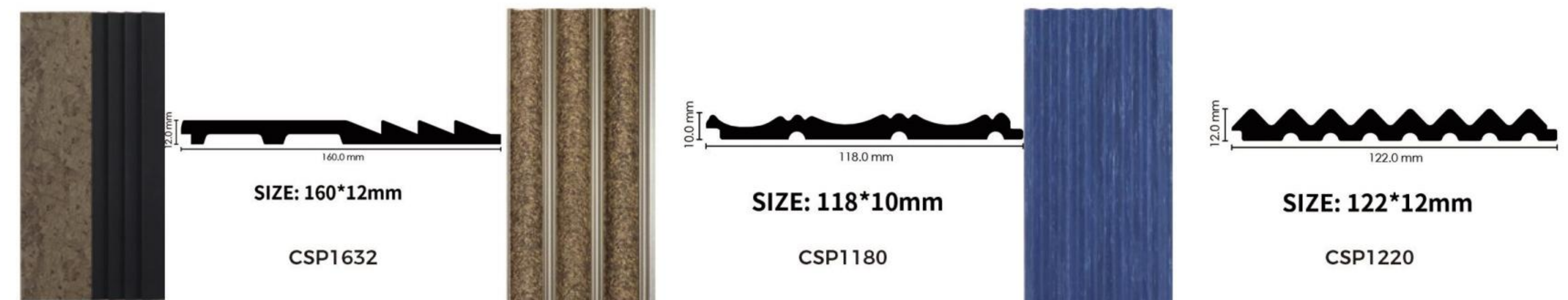
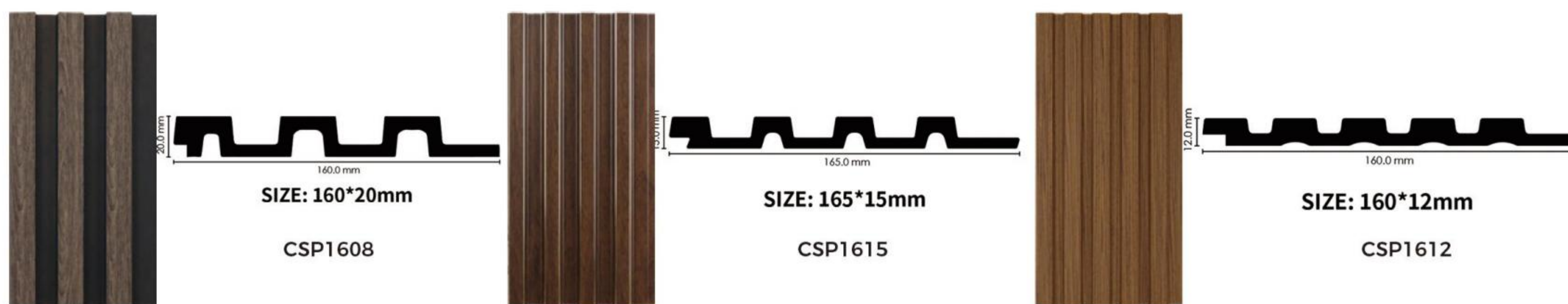
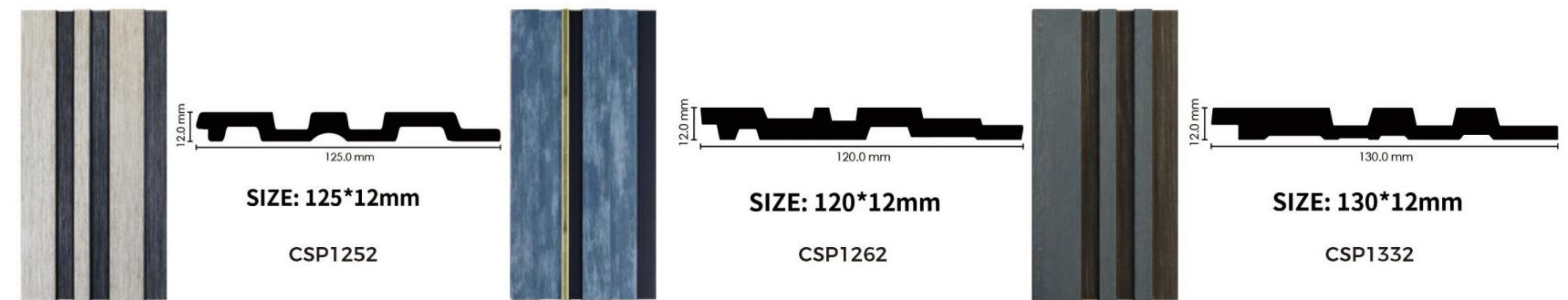
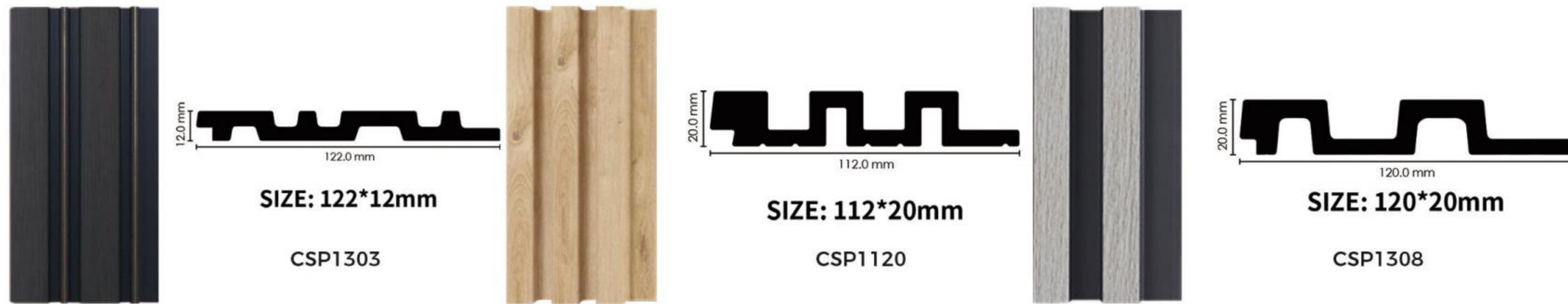
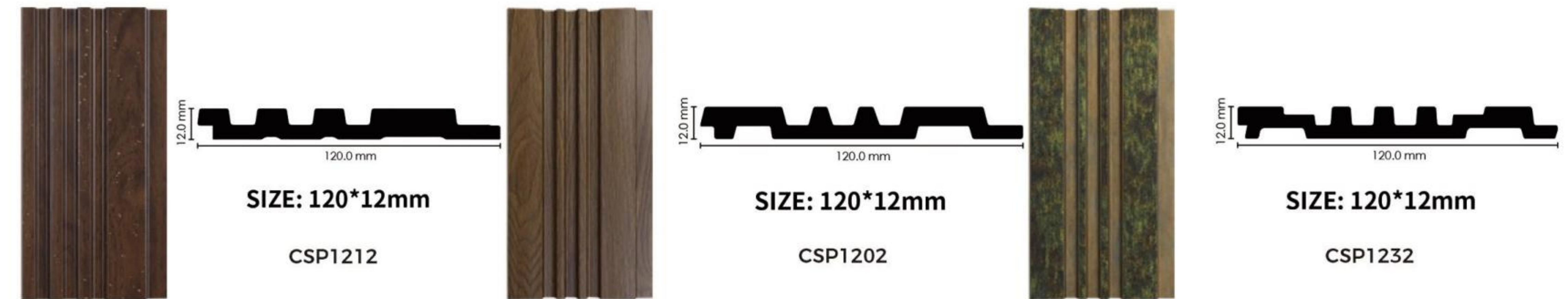
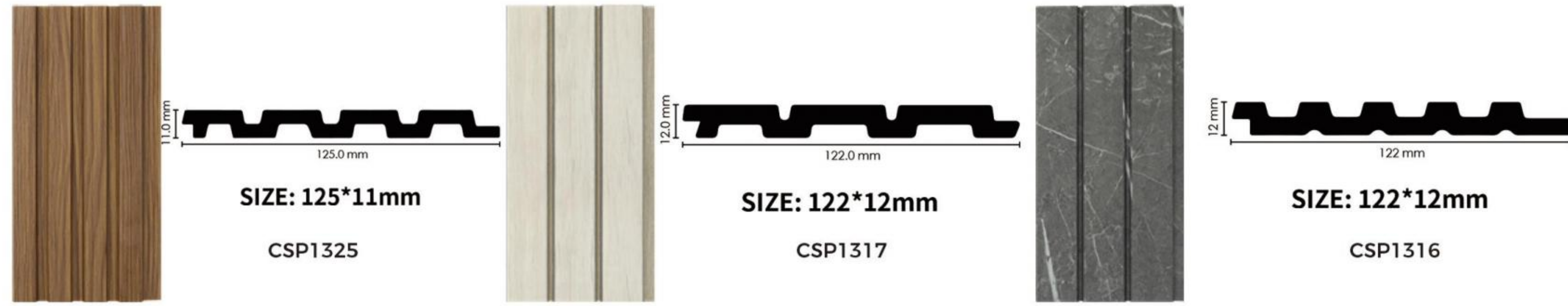
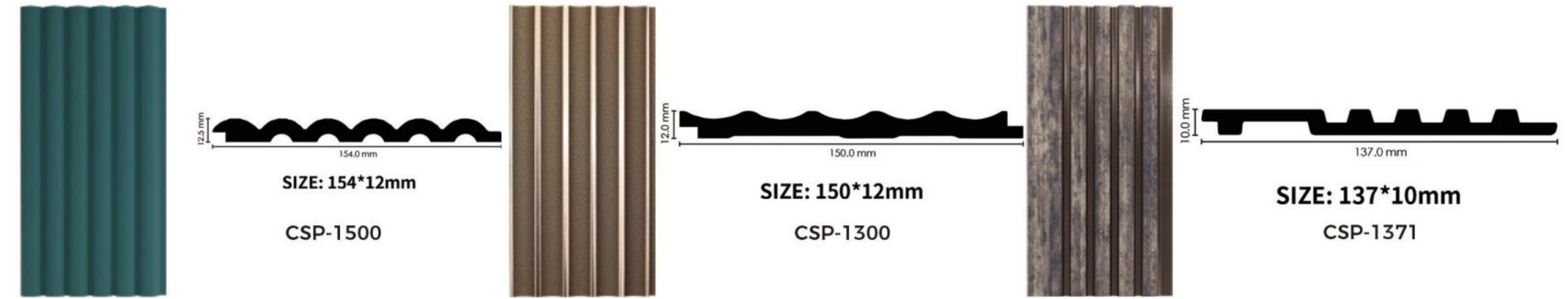
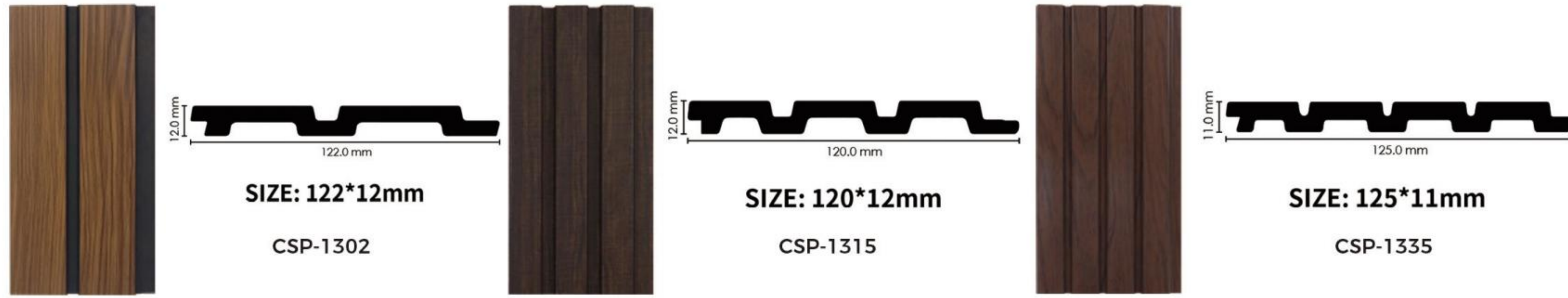

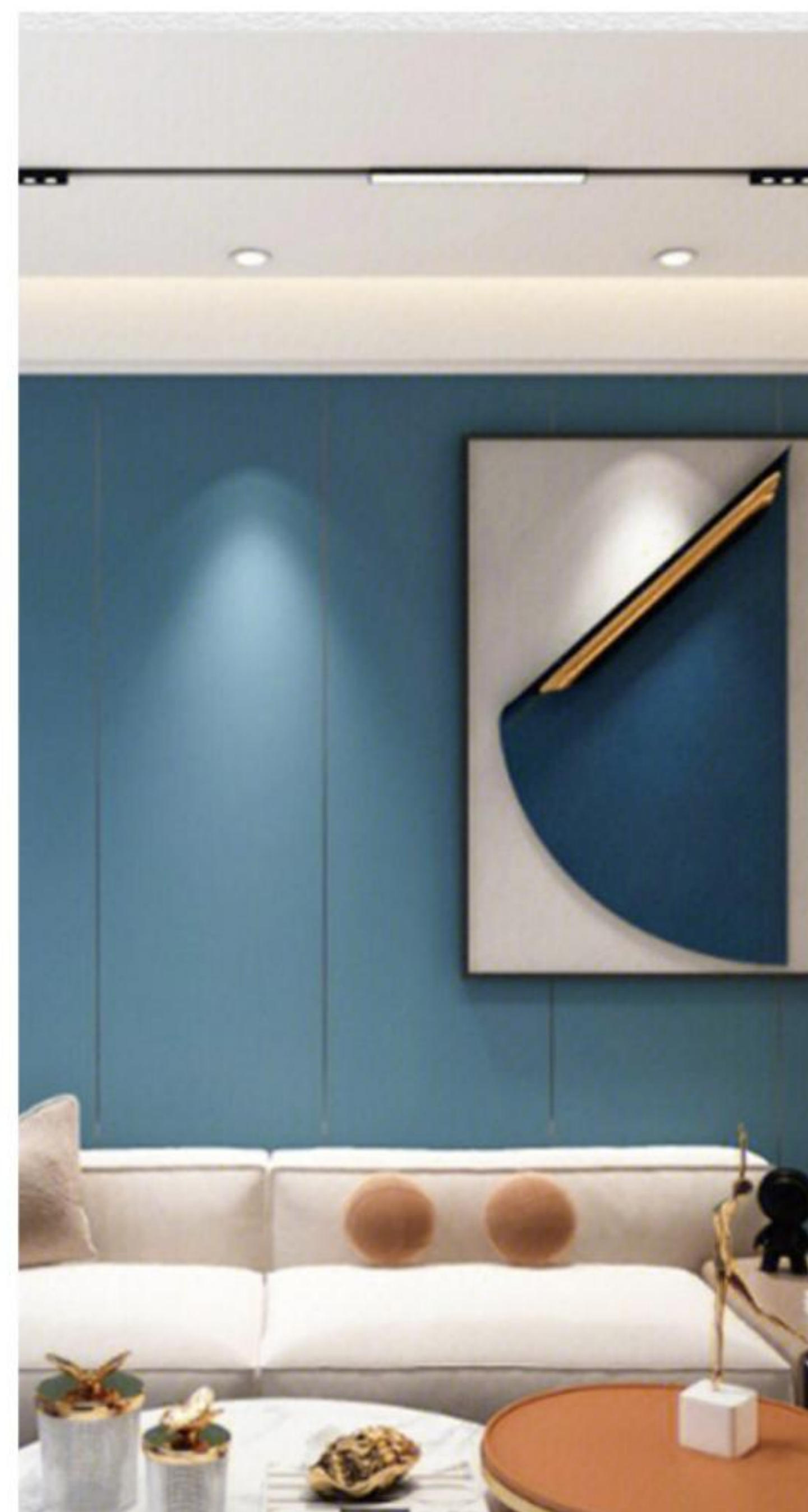

CSP-62001



CSP-62002



CSP-62003



CSP-62004



CSP-62005



CSP-62006



CSP-62007

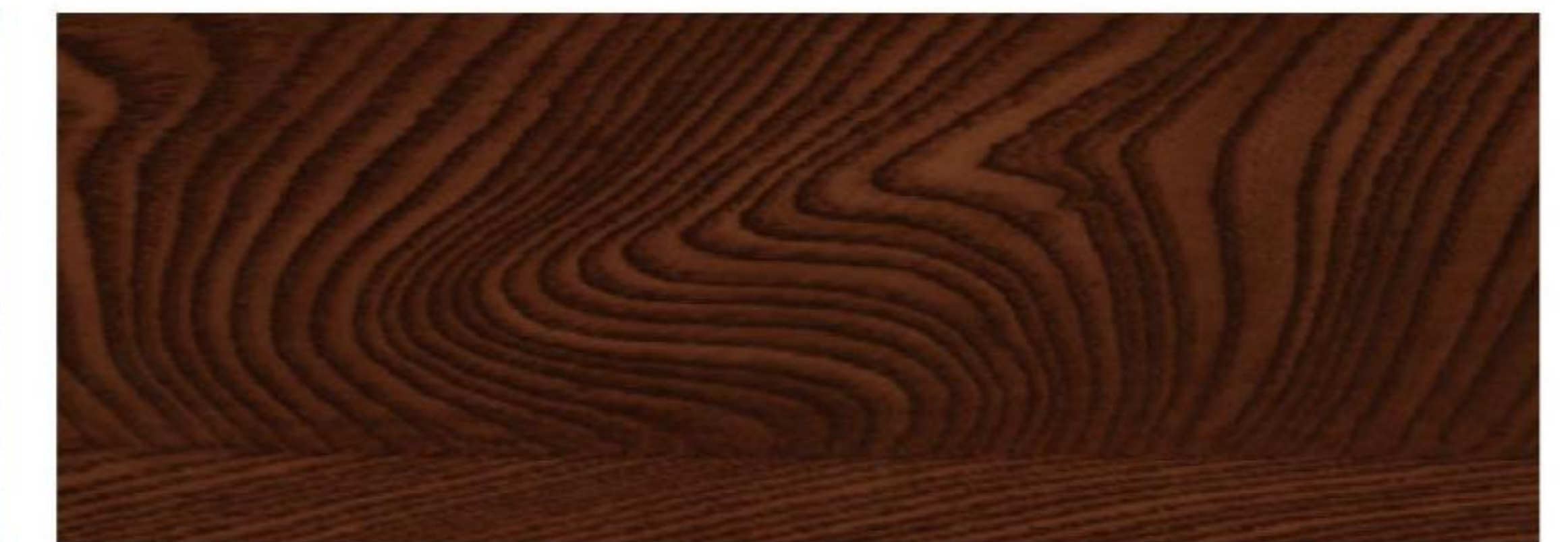

CSP-62008



CSP-62009



CSP-62010



CSP-62011



CSP-62012

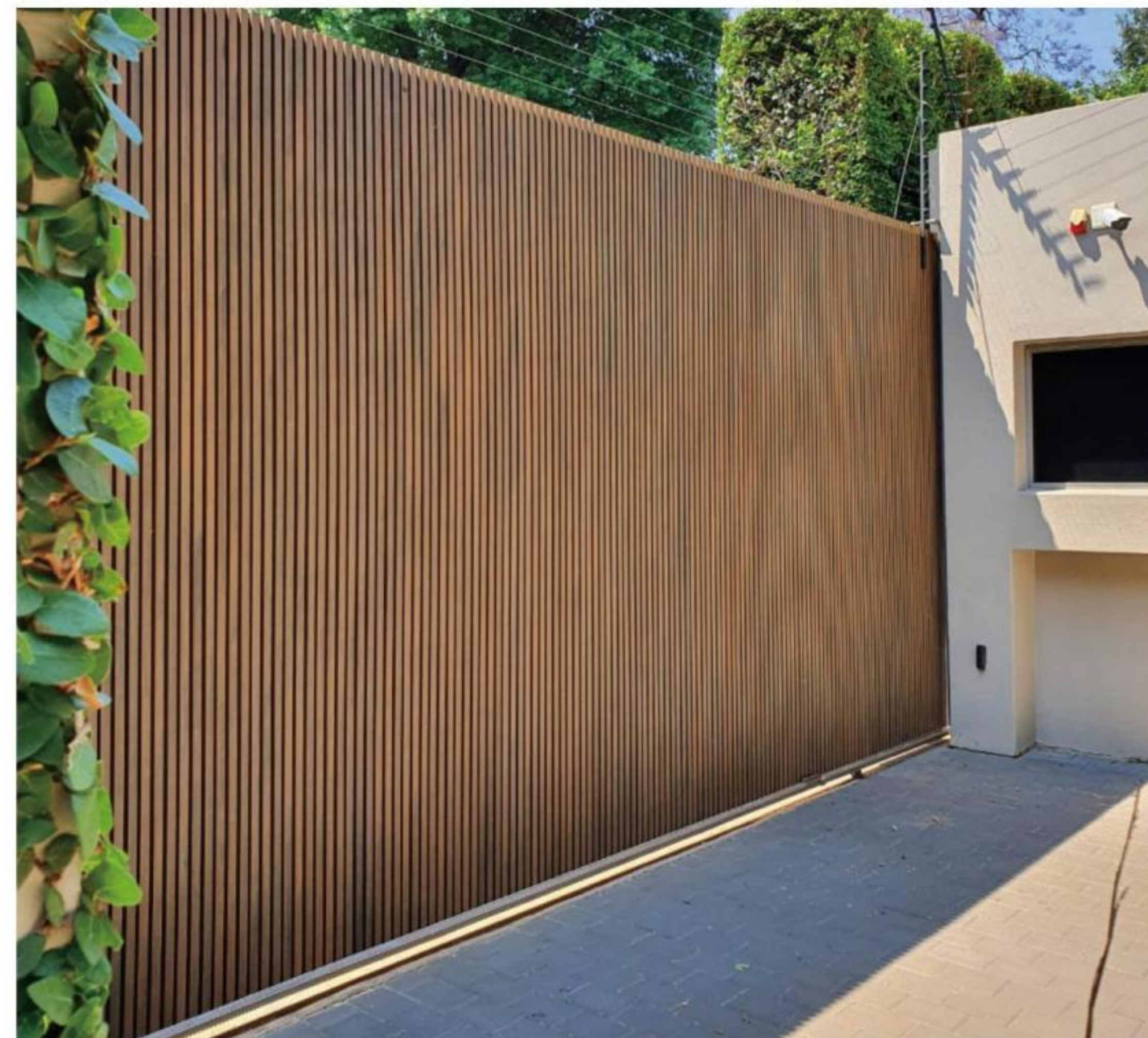

◆ WALL BOARD

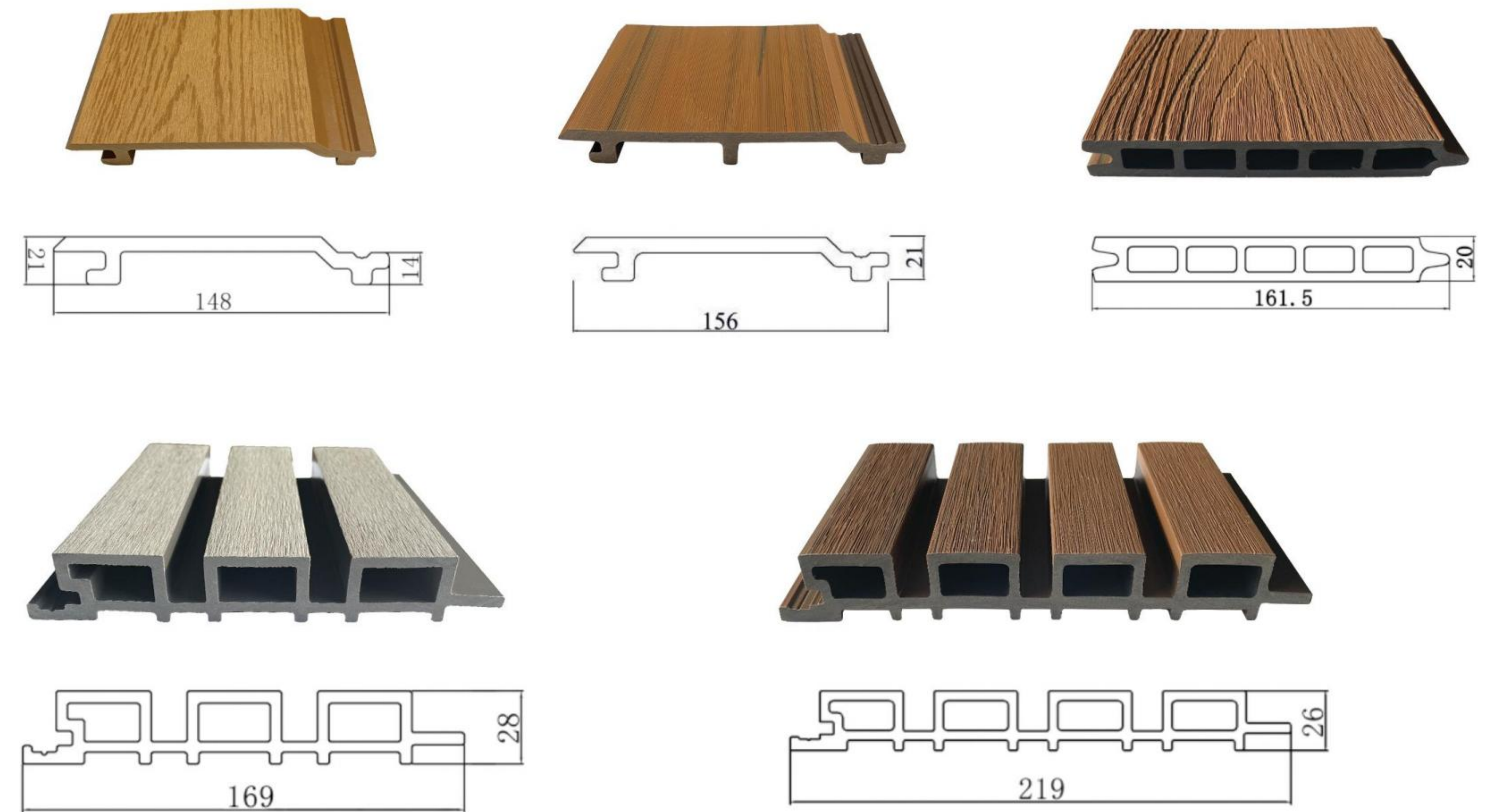

◆ COLOUR CARD





CSF-21001



CSF-21002



CSF-21003



CSF-21004



CSF-21005



CSF-21007



CSF-21008



CSF-22007



CSF-22002



CSF-22003



CSF-22004



CSF-22005



CSF-22009



CSF-22010



CSF-23009



CSF-23001



CSF-23002



CSF-23003

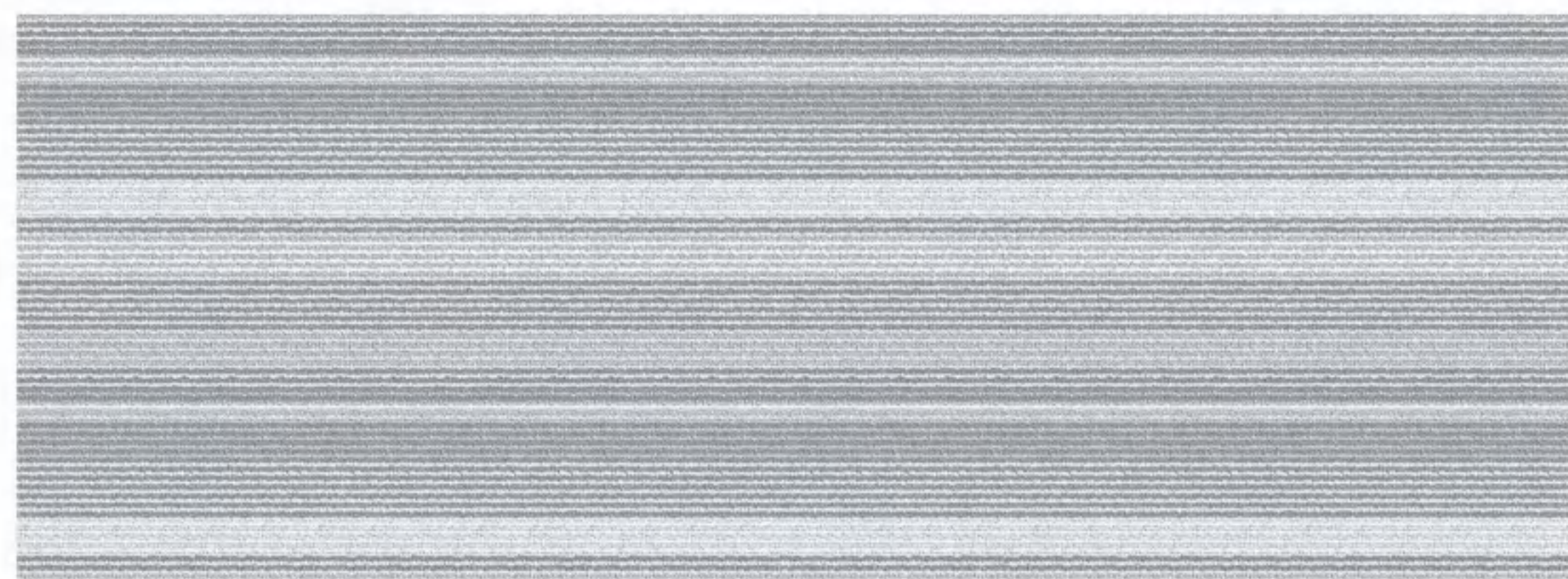

CSF-23004



CSF-23005



CSF-23007



Deep Wood



Plain Lines(Crystal Line)



Slate(stone)



Orange Peel(coralline)



Carpet Texture



Hand-Scraped(knife chop)

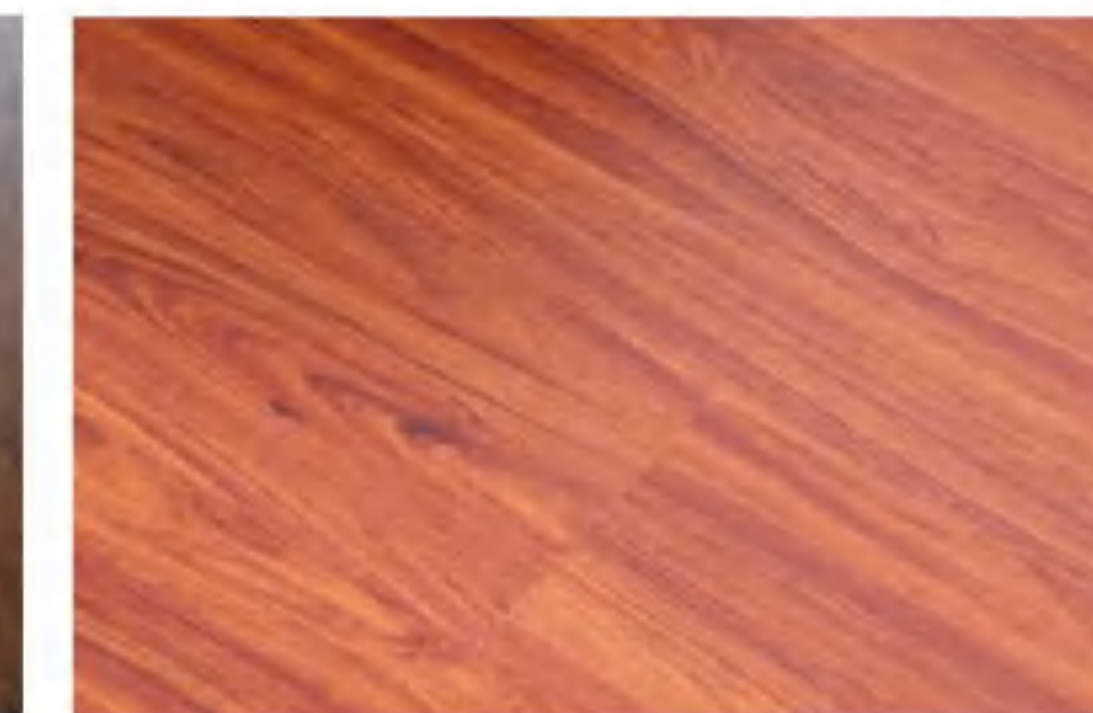

Flat grain



Plain Skin

Types



Self-Adhesive



Dry Back



Click



Loose Lay



3'x24" 76.2mmx609.6mm	3'x12" 76.2mmx304.8mm
3'x48" 76.2mmx1219.2mm	
6'x36" 152.4mmx914.4mm	
6'x48" 152.4mmx1219.2mm	
7.2'x36" 183mmx915mm	
7'x48" 177.8mmx1219.2mm	
9'x36" 228.6mmx914.4mm	
9'x48" 228.6mmx1219.2mm	

12'x12" 304.8mmx304.8mm	12'x18" 304.8mmx457.2mm
12'x24" 304.8mmx609.6mm	
18'x36" 457.2mmx914.4mm	
18'x18" 457.2mmx457.2mm	24'x24" 609.6mmx609.6mm
9'x9" 224mmx224mm	10'x10" 250mmx250mm



CSF-31001



CSF-31002



CSF-31003



CSF-31004



CSF-31006



CSF-31008



CSF-31009



CSF-32007



CSF-32001



CSF-32002



CSF-32003



CSF-32004



CSF-32005



CSF-32006



CSF-33001

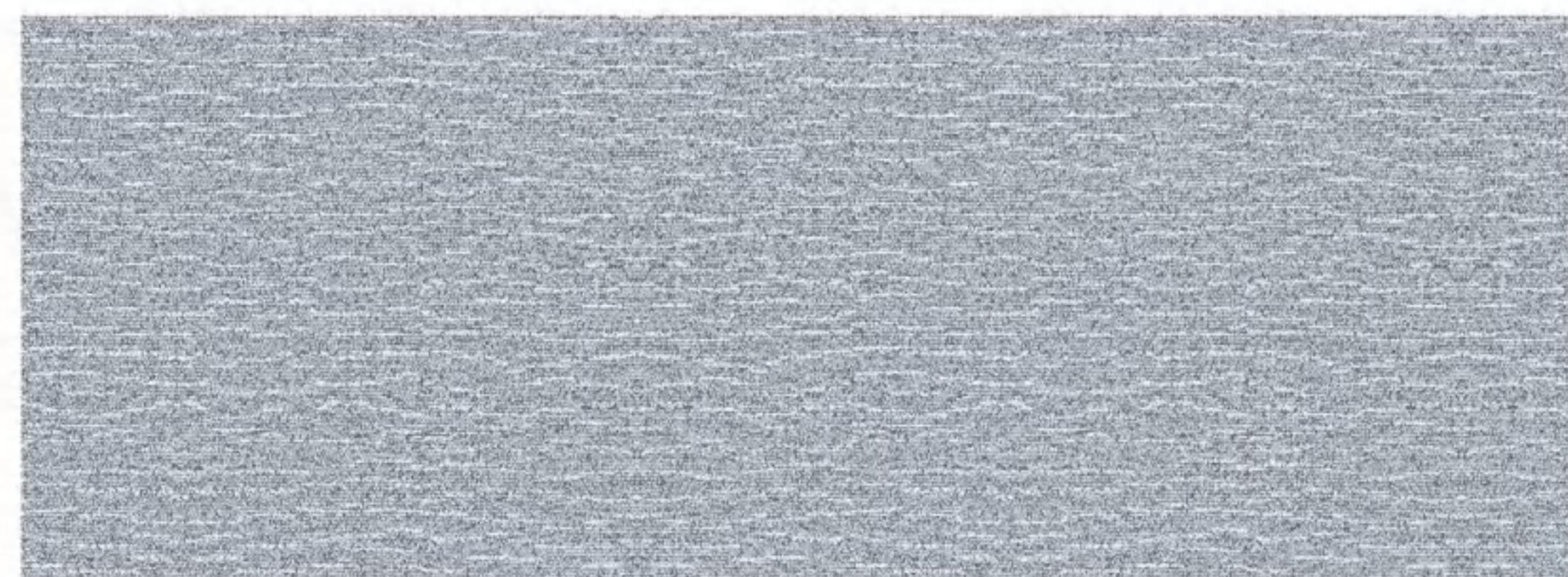

CSF-33003



CSF-33005

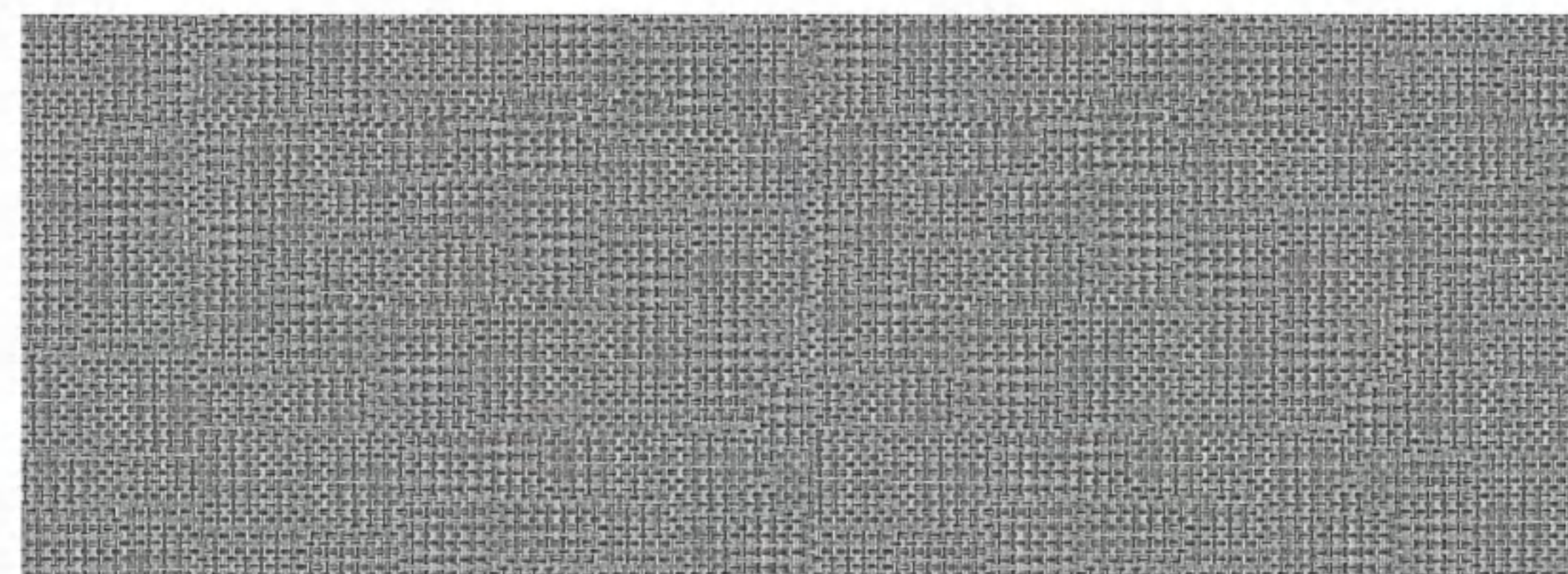

CSF-33006



CSF-33008



CSF-33010



CSF-33011

• The advantage of stone plastic floor

SPC flooring environmental performance is much better than that of laminate flooring, no formaldehyde emission; its material is recyclable and environment. SPC flooring provides superior water & erosion resistance let you install especially in high moisture areas, including bathrooms, kitchens, basement and laundry rooms, it is ideal choices for residential use. It is fire retardant and with high heat resistance compared with solid wood or laminated flooring.



Unilin Click Installation



Adopting UNILIN locking system, SPC Flooring installation is easier and faster, flooring planks lay together without glue. Tight & even interlock technology avoids crash of edges and water leakage, protects for a lifetime of beauty. 4-side beveled edges are available to enhance three-dimensional feel and increase its realistic texture.

SPC flooring environmental performance is much better than that of laminate flooring, no formaldehyde emission, its material is recyclable and environment. SPC flooring provides superior water & erosion resistance let you install especially in high moisture areas including bathrooms, kitchens, basement and laundry rooms, it is ideal choices for residential use. It is fire retardant and with high heat resistance compared with solid wood or laminated flooring.

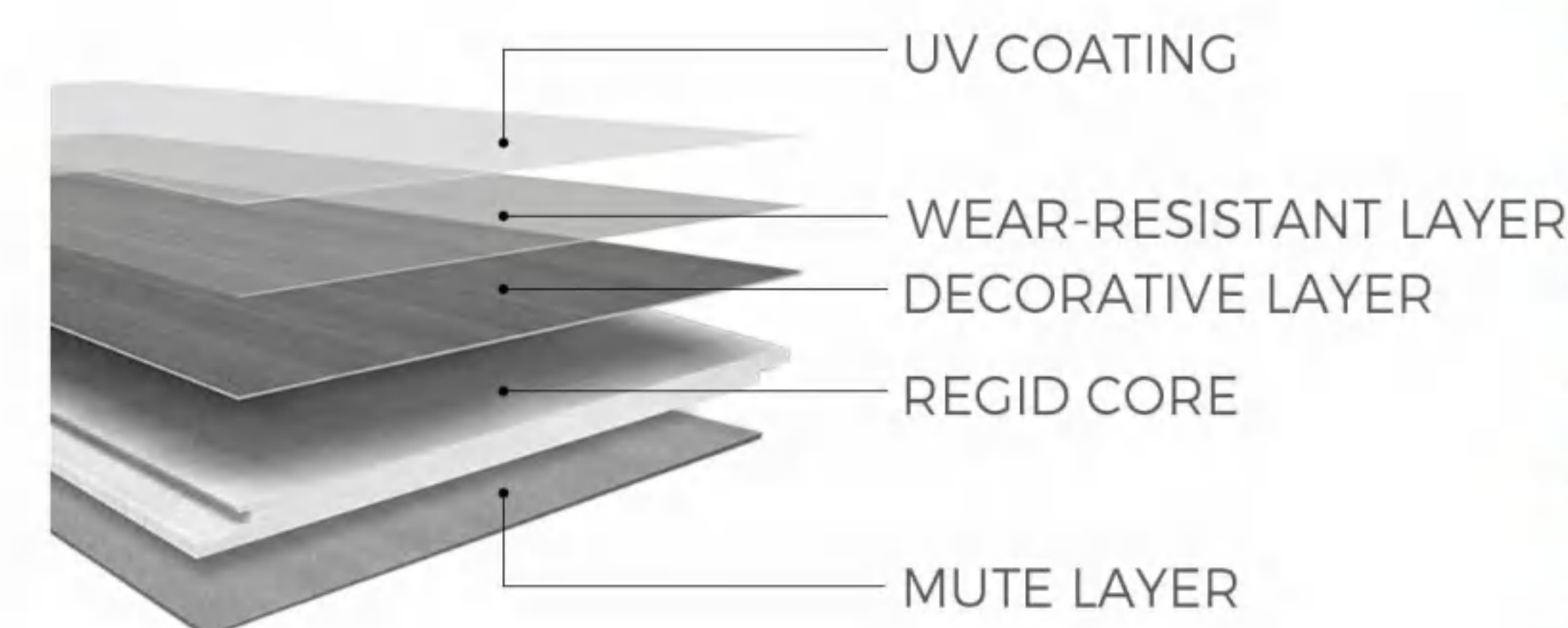

Thickness	3.5, 3.8, 4, 4.5, 5, 5.5, 6, 6.5, 7, 8(mm)		
Wear Layer	0.3mm, 0.5mm, 0.7mm		
Dimensions	150*912mm(6''*36'')	183*1220mm(7''*48'')	230*1220mm(9''*48'')
Backing Layer	100% new material		
Edge Detail	EVA, IXPE, Cork, etc.		
Surface Treatment	Squared edge & Beveled edge available		
Surface Texture	UV Coating		
	Wood Grain	Stone Pattern	Orange Peel
	Flat grain	Impact Grain	Hand-scraped Grain
	Waterproof	Strong Stability	Formaldehyde-Free
	Fireproof	Non-Slip	Varieties Design
Installation	Easy Installation	Unilin Click	DIY installation
Application	Indoor area, Decoration material, Office, Hospital, Hotel, School, Shopping center, Household, Residential and Commercial etc.		

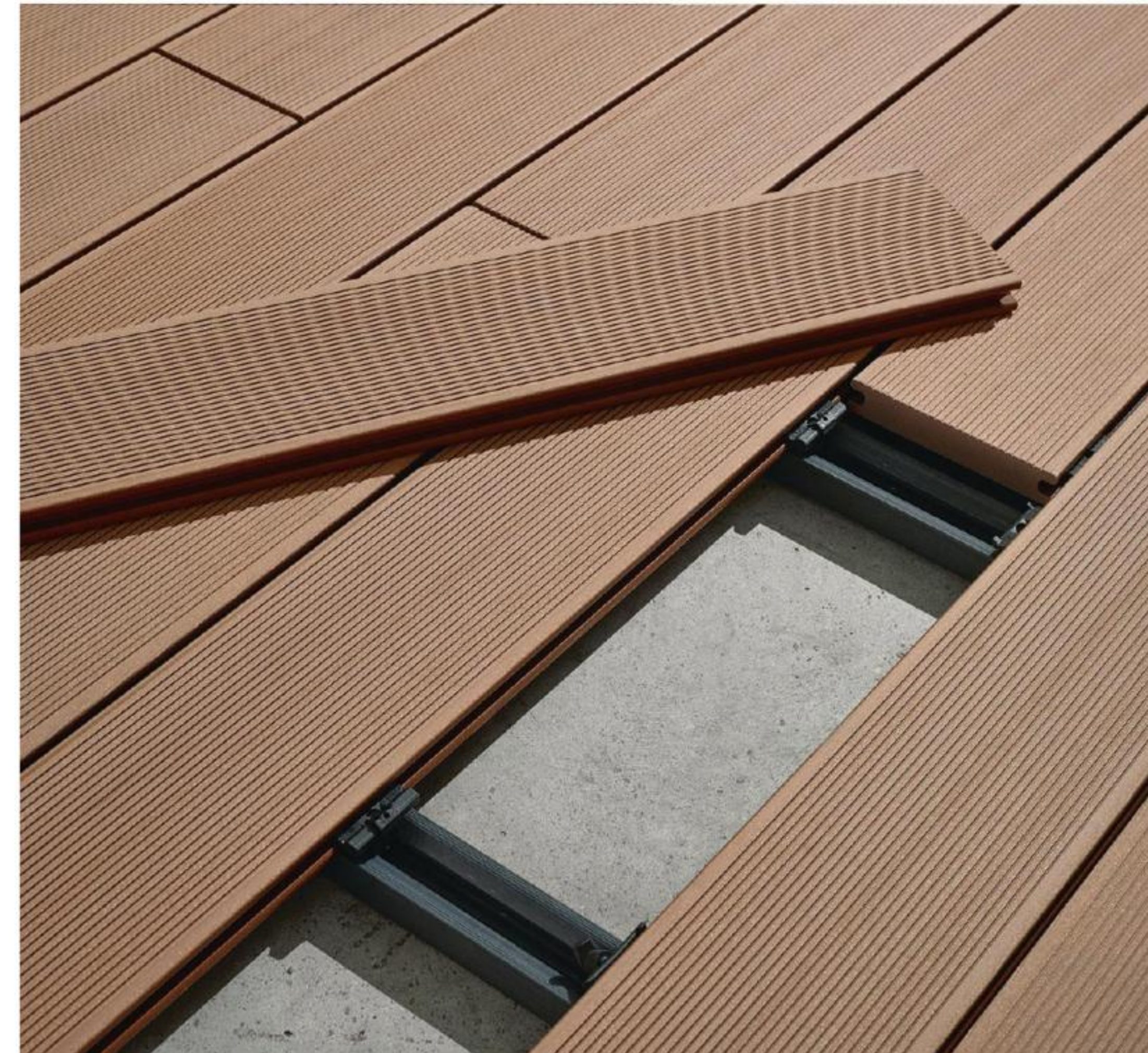

◆ SURFACE TREATMENT



PINSTRIPES BRUSHED PATTERN CO-EXTRUSION DRAGON PATTERN 3D EMBOSSING HEART PATTERN



SQUARE ROUND SOLID

SQUARE	Width	-	140mm	140mm	145mm	146mm	150mm	150mm	-
	Thickness	-	25mm	30mm	22mm	25mm	20mm	25mm	-
	Weight(Kg/m)	-	2.6	2.92	2.45	2.45	2.45	2.7	-
ROUND	Width	140mm	140mm	140mm	-	-	-	150mm	150mm
	Thickness	23mm	25mm	30mm	-	-	-	25mm	40mm
	Weight(Kg/m)	2.95	3.06	3.4	-	-	-	3	4.5
SOLID	Width	140mm	140mm	-	-	-	-	-	-
	Thickness	23mm	25mm	-	-	-	-	-	-
	Weight(Kg/m)	4.1	4.65	-	-	-	-	-	-

*THE METER WEIGHT IS RELATED TO THE PRODUCT DENSITY AND SUPPORTS CUSTOMIZATION

◆ COLOUR CARD

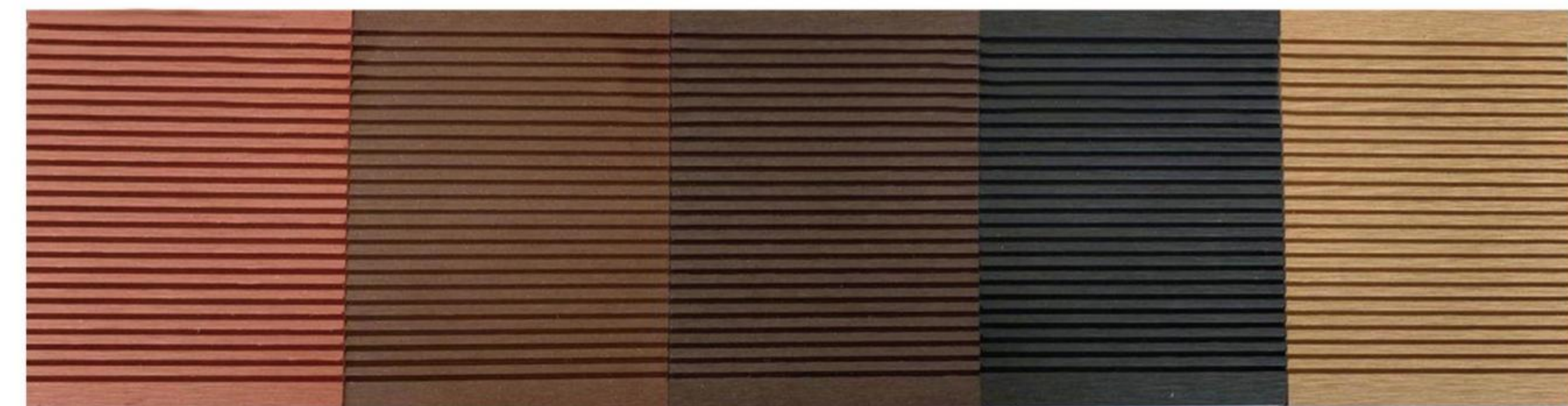

RED WALNUT BROWN BLACK TEAK

◆ SKIRTING



2400x80x12mm



2400x100x12mm



2400x90x15mm



2400x80x15mm

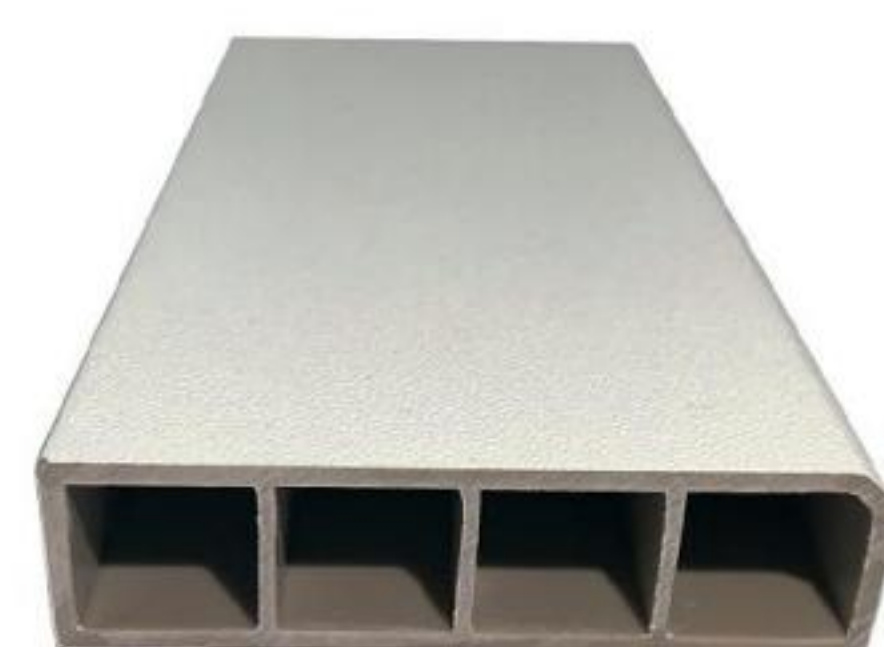

2400x50x13mm



2400x70x12mm



2400x90x15mm

◆ T-MOULDING



2400x45x6mm



2400x45x7/9mm

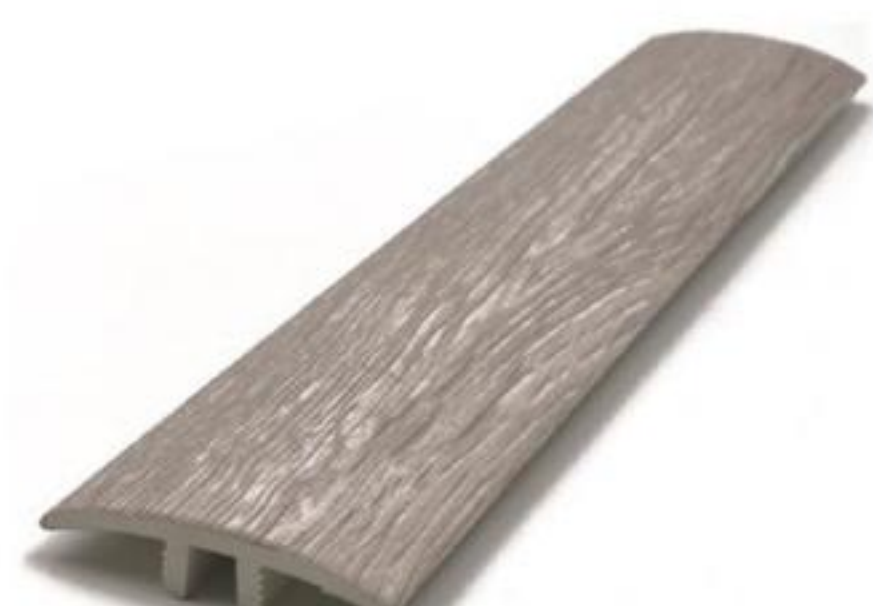

2400x35x7mm



2400x25x6mm

◆ STAIR NOSE



2400x55x18mm



2400x72x25mm



2400x72x25mm

◆ QUARTER ROUND



2400x28x15mm



2400x28x15mm

◆ REDUCER



2400x45x8mm



2400x28x15mm



2400x30x6mm



2400x36x8mm

◆ L-LINE



2400x24x15mm



2400x20x10mm



3000x25x25mm



3000x30x30mm

◆ INSIDE CORNER MOULDING



2400x24x15mm



2400x20x10mm



3000x31x19mm



3000x36x12mm

◆ MOULDINGS ALUMINUM WALL TRIM

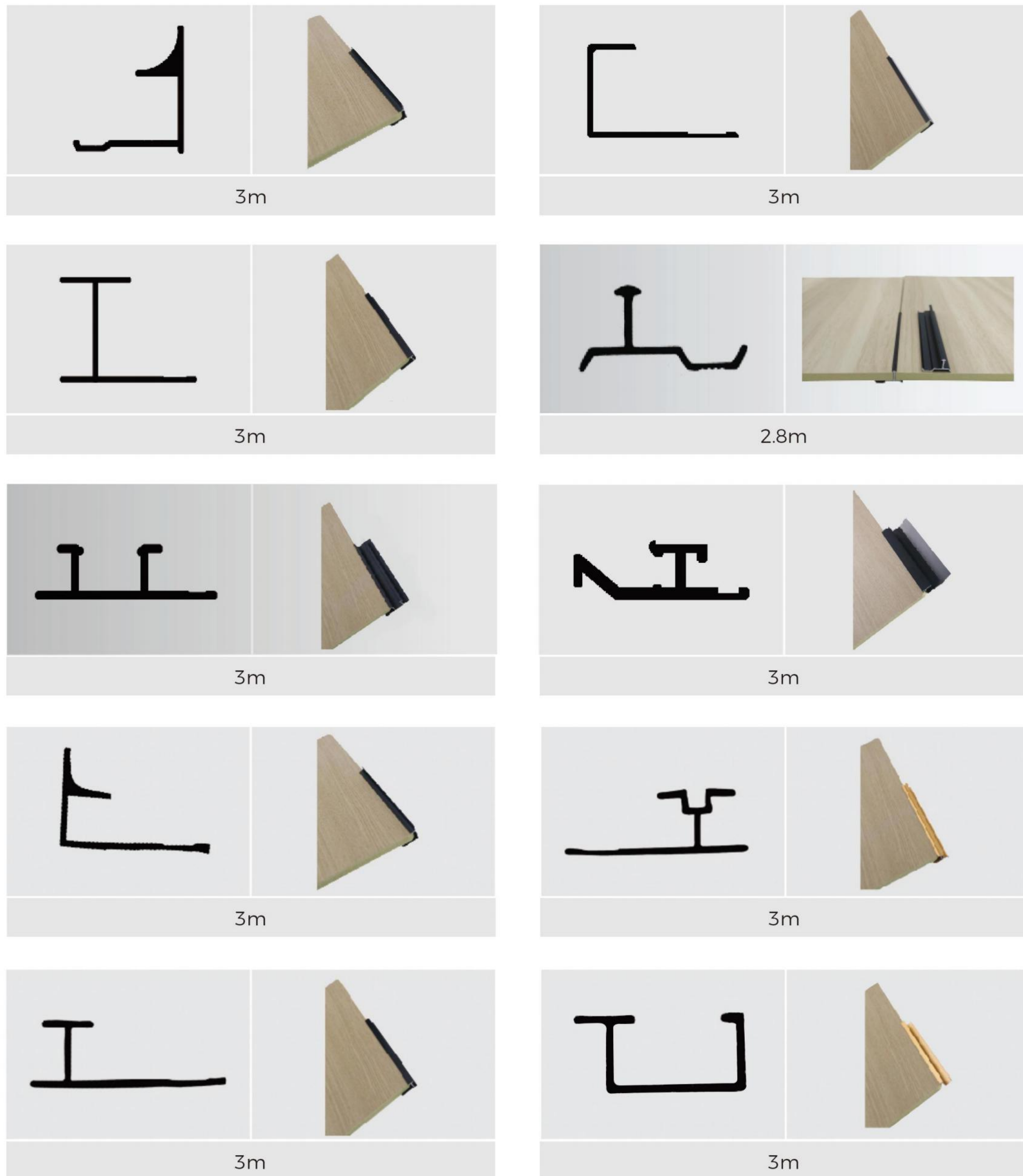

◆ MOULDING

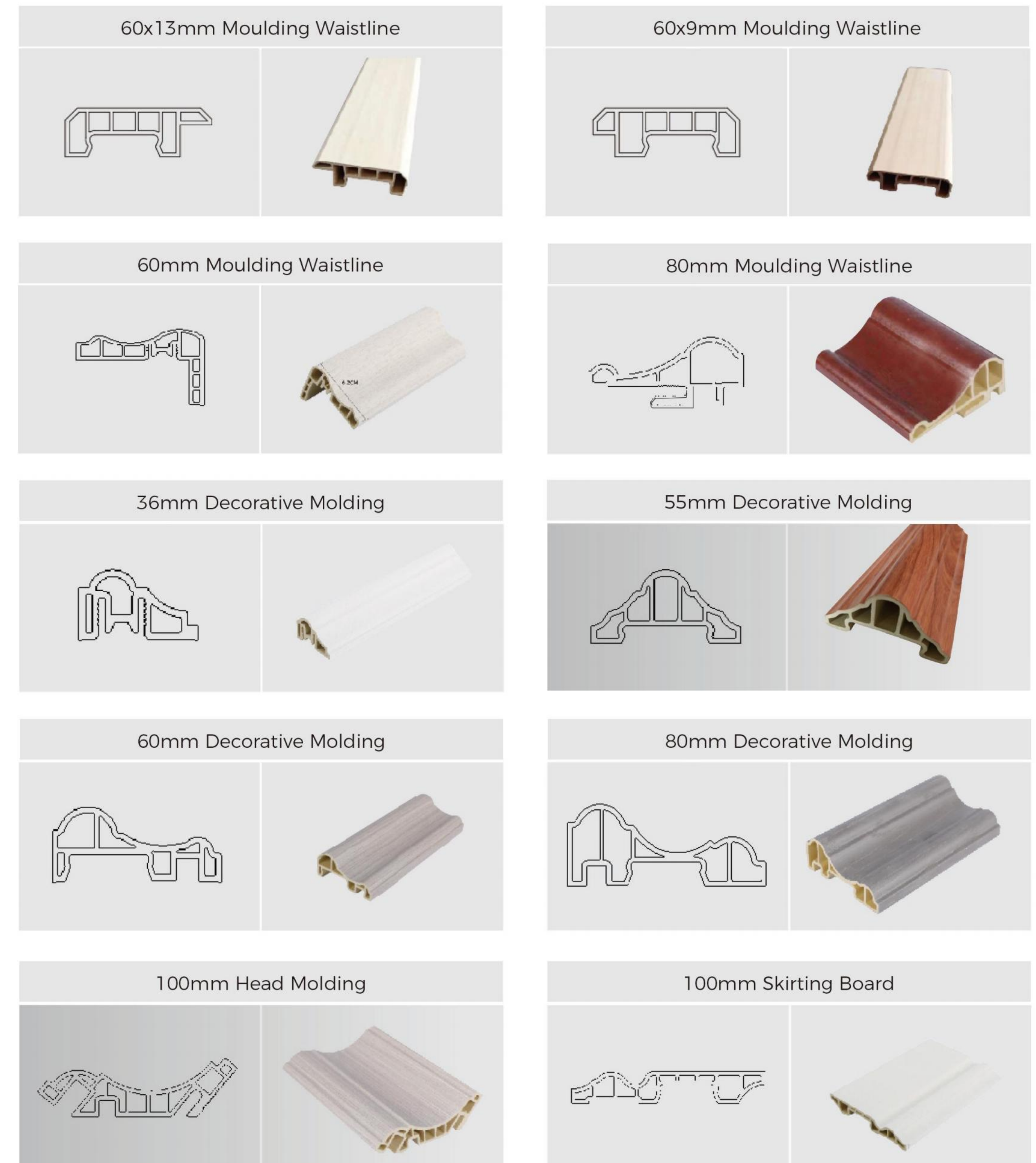

◆ CARPET GRIPPER



20mm Carpet Gripper Dual Purpose Nails



25mm Carpet Gripper Cement Nails



33mm Carpet Gripper Wood Nails



33mm Carpet Gripper Cement Nails

◆ OUTDOOR DECKING ACCESSORIES



Plastic Connectors



Stainless steel connectors



30x12mm Keel



51x16mm Keel

◆ CEILING INSTALLATION ACCESSORIES



25mm Louvre Blade



50mm Louvre Blade



Keel



Wall Panel Clamp

